

aerospace  
climate control  
electromechanical  
filtration  
fluid & gas handling  
hydraulics  
pneumatics  
process control  
sealing & shielding

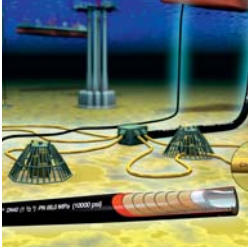

# Thermoplastic Hoses for the Oil and Gas Industry

Oil & Gas Catalogue – Global Edition

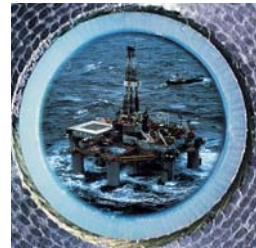

ENGINEERING YOUR SUCCESS.

## Thermoplastic Hoses for the Oil and Gas Industry Facilities



Hüttenfeld / Germany



Wissembourg / France



Almelo / Netherlands



Ravenna / Ohio



Stafford / Texas

### For Your Safety

The hose assemblies listed in this catalogue are all special constructions with the hose having up to eight spiral layers of steel wire. Due to this construction, pressures are achieved which far exceed German and international standards. These hose types are manufactured and tested according to the Polyflex standards which have proved to be effective over many years.

Polyflex hose assemblies are used at considerable working pressures. The critical area of a hose assembly is the connection between flexible hose and rigid fitting (crimping area). Only the use of original Polyflex components (hose, fittings and tooling) and full compliance with the Polyflex assembly instructions can guarantee safety and conformity with standards. It is essential that training be given to customers in the hose assembly process in order to make high quality Polyflex maximum pressure hose assemblies.

For the production and testing of the hose assemblies relevant to the applications, the guidelines and technical regulations as well as the protection and hazard prevention rulings must be adhered to.

You as the manufacturer of Polyflex hose assemblies are obliged to mark these hose assemblies according to the regulations and to verify their safety by a final pressure test.

Non-compliance with these rules can lead to the premature failure of the hose assembly and the loss of warranty.

- A** - *General Information*
- B** - *Umbilical and jumper hoses*
- C** - *BOP and hot-line hoses*
- D** - *High pressure hydraulic control and testing*
- E** - *Large bore hoses for use in well services*
- F** - *Hose umbilicals*
- G** - *High pressure adaptors, valves and NPT*
- H** - *Quick couplers*
- I** - *Accessories and tooling*
- J** - *Technical information*
- K** - *Index of part numbers*

## Introduction

The Parflex and Polyflex divisions of Parker Hannifin have been supplying a wide range of thermoplastic hose products to the oil and gas market for over 30 years.

With sizes ranging from 2 mm to 2" and working pressures from 6 bar to 60,000 psi they offer the widest range of thermoplastic hoses available.

With production plants in both the USA and Europe supported by Parker's global sales and distribution network, customers can benefit from local service and the supply of quality parts wherever they are situated.

This catalogue concentrates on the thermoplastic hoses and associated products such as umbilicals, adapters and couplings. For more information about Parker's other oil and gas products, such as marine transfer hoses and tube umbilicals contact your nearest Parker sales office.

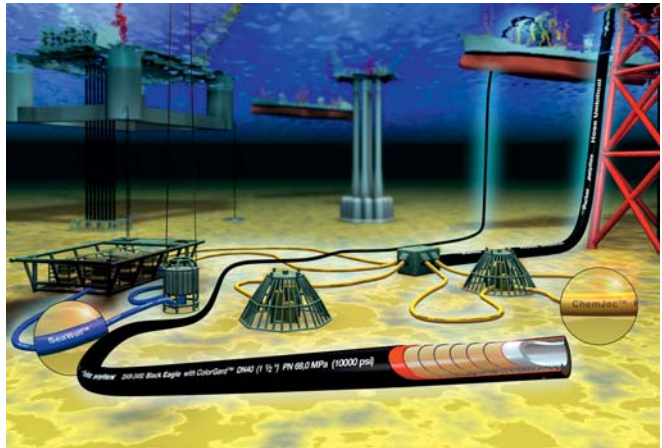



**Chapter A****General Information**

Hose fitting chart.....	A-2
Pressure and I.D. selection of hose .....	A-4
Hose part numbering system.....	A-6
Hose end fitting part numbering system.....	A-6
Explanation of symbols.....	A-7
Easy navigation .....	A-8

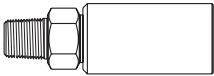
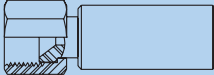
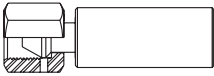
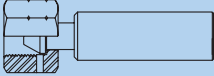
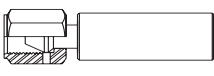
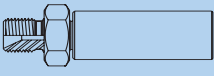
## Hose fitting chart

Fitting	Fitting description	Fitting designation
	National Pipe Tapered (NPT) Male Fitting	01
	JIC Female Swivel Fitting	06
	Type "M" Female Swivel Fitting	AY
	BSP Female Swivel Fitting	BC or 92
	Metric Female Swivel Fitting	C3 or C9
	BSP Male Fitting	D9 or 3B

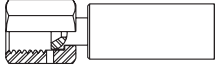
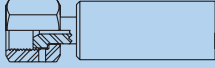
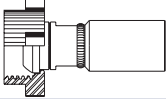
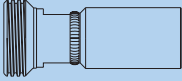
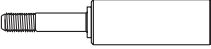
## Hose fitting chart

Fitting	Fitting description	Fitting designation
	Medium Pressure Female Swivel	5Y
	High Pressure Female Swivel	6Y
	Hammer Union (Male) Cone with Wing Nut End Fitting	HE
	Hammer Union (Female) Cone Threaded End with Seal	HN
	High Pressure Tube Nipple	Y4 or YM
	Medium Pressure Tube Nipple	Y2

## Pressure and I.D. selection of hose by application and working pressure (psi/MPa)

Dimensions Hose type	inch	1/8	3/16	1/4	5/16	3/8
	mm	3.2	4.8	6.4	7.9	9.5
	size	-02	-03	-04	-05	-06
	DN	3	5	6	8	10
<b>Umbilical and Jumper hoses – Textile reinforced</b>						
575X				5,000/34.5		5,000/34.5
2022NO				10,000/69.0		8,000/55.0
57CR						
<b>Umbilical and Jumper hoses – Wire reinforced – Nylon 11</b>						
2240N				6,200/43.0		
2370N						6,200/43.0
2380N				10,000/69.0		8,300/57.5
2390N						6,454/44.5
2440N				12,700/87.5		12,700/87.5
2640N						
2448N				15,000/103.5		15,000/103.5
<b>Umbilical and Jumper hoses – Wire reinforced – ChemJec</b>						
2240M				6,200/43.0		
2370M						6,200/43.0
2380M				10,000/69.0	9,060/60.0	
2440M				12,700/87.5	10,000/69.0	12,700/87.5
2448M				15,000/103.5	15,000/103.5	15,000/103.5
<b>BOP and hotline hoses – Textile reinforced</b>						
573LH			3,000/20.7			
H580N-16						
575LH			5,000/34.5			
575X-16						
<b>BOP and hotline hoses – wire reinforced</b>						
2390N						
593						
<b>Hydraulic control and testing – Textile reinforced</b>						
2020N		5,280/40.0				
520N			5,000/34.5	5,000/34.5	4,500/31.0	4,000/27.5
HP/HPX			10,000/69.0	10,000/69.0		10,000/69.0
<b>Hydraulic control and testing – Wire reinforced</b>						
2380N*						
2440N*						
<b>Large bore for well servicing</b>						
2440N				16,000/11.0	13,600/93.8	13,300/92.0
2640N*				23,800/164.0		23,000/140.0

Note: \* safety factor less than 4:1

1/2	3/4	1	1 1/4	1 1/2	2	Page
12.7	19	25.4	31.8	38.1	50.8	
-08	-12	-16	-20	-24	-32	
12	20	25	32	40	50	
5,000/34.5	5,000/34.5	5,000/34.5				B-2
						B-5
5,000/34.5		5,000/34.5				B-8
						B-10
5,080/35.0						B-13
8,000/55.0			4,000/27.5			B-16
6,019/41.5	5,076/35.0	4,061/28.0				B-19
11,700/81.0	9,100/63.0	8,120/56.0				B-22
16,400/113.0	12,760/88.0	10,880/75.0				B-26
						B-29
						B-31
5,080/35.0						B-34
						B-37
11,700/81.0						B-40
						C-2
		3,000/20.7				C-2
		5,000/34.5				C-2
9,570/66.0	8,120/56.0	6,530/45.0				C-4
	3,000/20.7	3,250/22.4				
3,500/24						D-4
						D-7
12,800/88.0						
23,000/140.0	14,900/103.0	13,100/90.0				
		8,120/56.0		5,000/34.5	5,000/34.5	E-2
		15,000/103.5		10,000/69.0	10,000/69.0	E-5

## Hose part numbering system



**2440 N - 16 V37**

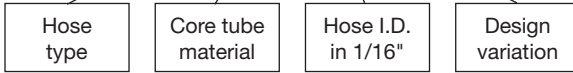

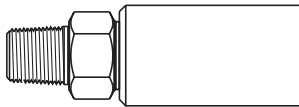

## Hose end fitting part numbering system



**6 01 LX - 8 - 8 C**



## Explanation of symbols

Symbol	Description
#	Part number
	Nominal inner diameter
	Nominal outer diameter
	Working pressure
	Burst pressure
	Bend radius
	Weight
	Fittings
	Thread size
	Wrench size
	Thickness

## Easy navigation

For your convenience there are several types of guides to make navigation through the catalogue easy. Use those who are best suited for your purpose.

### Tabs

#### Chapter tabs:

Located on top of each page, these tabs refer to chapters A to K:



#### Group tabs:

Located at the side of each page, these tabs designate the different product groups or themes:

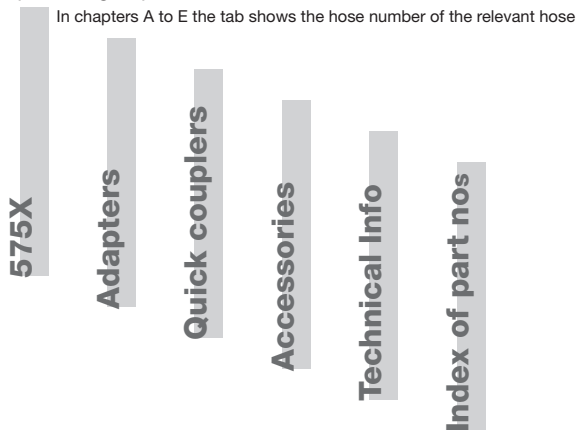

### Colours

Tables and headers use two different colours:

In chapters A to E **hose tables** are shown in blue. Each individual hose type is directly followed by the related **fitting tables**, which are shown in yellow colour.

### Symbols

For the meaning of the symbols which appear in table headers please refer to the previous page.

### Table of contents

The general table of contents on the first catalogue page refers to the different chapters, and each chapter starts with a table of contents referring to the contained sections.

### Index of part numbers

If you are searching for a special product by its part number, please use the alphanumeric index in chapter K.

---







**Chapter B****Umbilical and jumper hoses**

<b>Textile reinforced hoses and related fittings .....</b>	<b>B-2</b>
<b>575X</b> – Low volumetric expansion hose.....	B-2
<b>2022NO</b> – High pressure hose .....	B-5
<b>“Sea Wolf” hoses and related fittings.....</b>	<b>B-8</b>
<b>57CR</b> – High collapse resistant hose .....	B-8
<b>Wire spiral reinforced hoses and related fittings .....</b>	<b>B-10</b>
<b>V91 hoses with Nylon 11methanol washed core tube</b>	
<b>2240N (V91) – polyflex®</b> hose.....	B-10
<b>2370N (V91) – polyflex®</b> hose.....	B-13
<b>2380N (V91) – polyflex®</b> hose.....	B-16
<b>2390N (V91) – polyflex®</b> hose.....	B-19
<b>2440N (V91) – polyflex®</b> hose.....	B-22
<b>2448N (V91) – polyflex®</b> hose.....	B-26
<b>2640N (V91) – polyflex®</b> hose.....	B-28
<b>Chemjec hoses with fluoropolymer co-extruded core tube</b>	
<b>2240M (V30) – polyflex® hose ChemJec</b> .....	B-31
<b>2370M (V30) – polyflex® hose ChemJec</b> .....	B-34
<b>2380M (V30) – polyflex® hose ChemJec</b> .....	B-37
<b>2440M (V30) – polyflex® hose ChemJec</b> .....	B-41
<b>2448M (V30) – polyflex® hose ChemJec</b> .....	B-43

## 575X – Low volumetric expansion hose



575X

#														
	size DN	inch mm	inch mm	psi MPa	psi MPa	inch mm	lbs/ft kg/m							
575X-4	-04	1/4	0.51	5,000	20,000	2.00	0.101			55				
	6	6.4	13.0	34.5	138.0	50.8	0.15							
575X-6	-06	3/8	0.65	5,000	20,000	3.00	0.134			55				
	10	9.5	16.5	34.5	138.0	76.2	0.20							
575X-8	-08	1/2	0.81	5,000	20,000	4.00	0.207			55				
	12	12.7	20.6	34.5	138.0	101.6	0.31							
575X-12	-12	3/4	1.15	5,000	20,000	8.00	0.359			58H				
	20	19.0	29.2	34.5	138.0	203.2	0.53							
575X-16	-16	1	1.59	5,000	20,000	10.00	0.536			58H				
	25	25.4	40.4	34.5	138.0	254.0	0.80							

### Construction

**Core tube:** Polyamide  
**Pressure reinforcement:** One or two braided layers of high tensile aramid fibre  
**Cover:** Special polyurethane, black

### Applications

Long length hose and hose umbilicals requiring lightweight construction.

### Temperature range

-40°C up to +100°C, max. 70°C for water or methanol based fluids.  
 -40°F up to +212°F, max. 158°F for water or methanol based fluids.  
 Consult Parker for more detailed information.

### Remarks

For product with methol washed nylon core tube use suffix /OS e.g. 575X-4/OS.

## 10155/10158H – NPT male - 60° cone

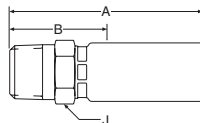

#	⊙		⌚	A	B	J	↻
	size DN	inch mm					
10155-4-4C	-04	1/4	1/4 - 18NPTF	2.32	1.18	0.71	5,000
	6	6.4		59.0	30.0	18	34.5
10155-6-6C	-06	3/8	3/8 - 18NPTF	2.68	1.30	0.75	5,000
	10	9.5		68.0	33.0	19	34.5
10155-8-8C	-08	1/2	1/2 - 14NPTF	3.07	1.57	0.94	5,000
	12	12.7		78.0	40.0	24	34.5
10158H-12-12C	-12	3/4	3/4 - 14NPTF	3.90	1.69	1.25	5,000
	20	19.0		99.0	43.0	32	34.5
10158H-16-16C	-16	1	1 - 11 1/2NPTF	4.76	1.81	1.75	5,000
	25	25.4		121.0	46.0	44	34.5

## Material

Stainless steel (AISI 316), other materials on request.

## 10655/10658H – JIC female swivel fitting

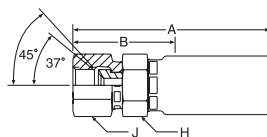

#	⊙		⌚	A	B	H	J	↻
	size DN	inch mm						
10655-4-4C	-04	1/4	7/16 - 20UNF	2.52	1.38	0.63	0.63	5,000
	6	6.4		64.0	35.0	16	16	34.5
10655-6-6C	-06	3/8	9/16 - 18UNF	2.80	1.50	0.75	0.75	5,000
	10	9.5		71.0	38.0	19	19	34.5
10655-8-8C	-08	1/2	3/4 - 16UNF	3.11	1.61	0.87	0.94	5,000
	12	12.7		79.0	41.0	22	24	34.5
10658H-12-12C	-12	3/4	1 1/16 - 12UNF	4.13	1.81	1.31	1.31	5,000
	20	19.0		105.0	46.0	33	33	34.5
10658H-16-16C	-16	1	1 5/16 - 12UNF	4.88	1.93	1.63	1.63	5,000
	25	25.4		124.0	49.0	41	41	34.5

## Material

Stainless steel (AISI 316), other materials on request.

## 1C955 – Metric swivel with O-Ring Heavy series

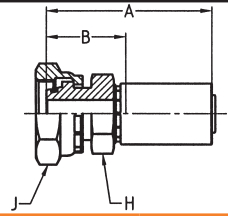

#	○		⌄	A	B	⬡ H	⬡ J	↗
	size DN	inch mm						
1C955-10-4C	-04	1/4	M18x1.5	2.64	1.42	0.75	0.87	5,000
	6	6.4		67.1	36.1	19	22	34.5
1C955-12-6C	-06	3/8	M20x1.5	2.68	1.26	0.75	0.94	5,000
	10	9.5		68.0	32.0	19	24	34.5
1C955-16-8C	-08	1/2	M24x1.5	3.03	1.42	0.94	1.18	5,000
	12	12.7		77.0	36.1	24	30	34.5

### Material

Stainless steel (AISI 316), other materials on request.

575X

## 2022NO – High pressure hose



#	○		○	○	✂	↷	⌋	⌋
	size DN	inch mm	inch mm	psi MPa	psi MPa	inch mm	lbs/ft kg/m	
2022NO-04V12	-04	1/4	0.58	10,000	40,000	3.94	0.10	NX-OF
	6	6.4	14.8	69.0	276.0	100.1	0.15	
2022NO-06V12*	-06	3/8	0.72	8,000	32,000	4.72	0.15	NX-OF
	10	9.5	18.4	55.0	220.0	119.9	0.23	

\*: consult factory

### Construction

**Core tube:** Polyamide 11, methanol washed  
**Pressure reinforcement:** High tensile aramid fibre braids  
**Cover:** HP hose: Polyurethane, blue

### Applications

Long length hose and hose umbilicals requiring lightweight construction.

### Temperature range

-40°C up to +100 °C,  
 max. 70 °C for water or methanol based fluids.  
 -40°F up to +212 °F,  
 max. 158 °F for water or methanol based fluids.  
 Consult Parker for more detailed information.

## 106NX – JIC female swivel fitting

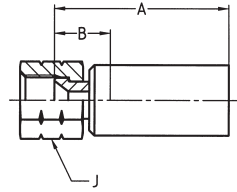

#	⊙		⌚	A	B	J	↗
	size DN	inch mm		inch mm	inch mm	inch mm	
106NX-4-04-OF	-04	1/4	7/16 - 20UNF	2.24	1.02	0.75	10,000
	6	6.4		57.0	26.0		
106NX-6-04-OF	-04	1/4	9/16 - 18UNF	2.17	0.91	0.87	10,000
	6	6.4		55.0	23.0		
106NX-8-06-OF	-06	3/8	3/4 - 16UNF	2.32	0.75	0.94	8,000
	10	9.5		59.0	19.0		

### Material

Stainless steel (AISI 316), other materials on request.

## 192NX – BSP female swivel fitting

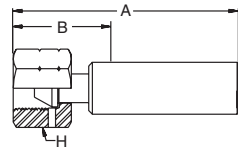

#	⊙		⌚	A	B	H	↗
	size DN	inch mm		inch mm	inch mm	inch mm	
192NX-4-04-OF	-04	1/4	G 1/4	2.20	0.98	0.75	10,000
	6	6.4		56.0	25.0		
192NX-6-06-OF	-06	3/8	G 3/8	2.32	0.75	0.87	8,000
	10	9.5		59.0	19.0		

### Material

Stainless steel (AISI 316), other materials on request.

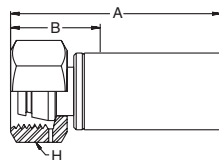
**1C9NX – Metric swivel fitting with O-ring  
Heavy series**

#	○		~~~~~	A	B	⬡ H	↗
	size DN	inch mm					
1C9NX-8-04-OF	-04	1/4	M16 x 1.5	2.32	1.06	0.75	10,000
	6	6.4		59.0	27.0	19	69.0
1C9NX-10-04-OF	-04	1/4	M18 x 1.5	2.56	1.30	0.87	10,000
	6	6.4		65.0	33.0	22	69.0
1C9NX-12-06-OF	-06	3/8	M20 x 1.5	2.80	1.18	1.18	8,000
	10	9.5		71.0	30.0	30	55.0





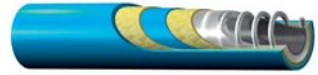

**Material**

Stainless steel (AISI 316), other materials on request.

## 57CR – High collapse resistant hose “Sea Wolf”



57CR “Sea Wolf”

#														
	size DN	inch mm	inch mm	psi MPa	psi MPa	inch mm	lbs/ft kg/m							
57CR-08V02	-08	1/2	1.18	5,000	20,000	6.25	0.630	CR						
	12	12.7	30.0	34.5	138.0	158.8	0.94							
57CR-08V06	-08	1/2	1.18	5,000	20,000	6.25	0.630	CR						
	12	12.7	30.0	34.5	138.0	158.8	0.94							
57CR-16V02	-16	1	2.00	5,000	20,000	10.75	10,750	CR						
	25	25.4	50.8	34.5	138.0	273.1	15.99							
57CR-16V06	-16	1	2.00	5,000	20,000	10.75	10,750	CR						
	25	25.4	50.8	34.5	138.0	273.1	15.99							

### Construction

**Core tube:** Polyamide, reinforced by a patent-pending stainless steel helix support  
**Pressure reinforcement:** High tensile aramid fibre  
**Cover:** Polyurethane, V02: blue, V06: yellow

### Applications

Offshore oil field exploration and production for use with petroleum, synthetic hydraulic oils, water and water based hydraulic fluids. Hose is not recommended for high pressure pneumatic service applications.

### Temperature range

-40°C up to +100°C, max. 70°C for water or methanol based fluids.  
 -40°F up to +212°F, max. 158°F for water or methanol based fluids.  
 Consult Parker for more detailed information.

### Remarks

Rated unsupported collapse resistance up to 3000 m water depth.

## 606CR – JIC female swivel fitting

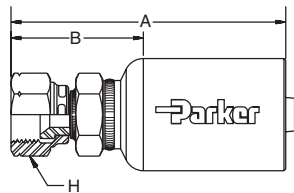

#	⊙		⌚	A	B	⬡	⊙
	size DN	inch mm		inch mm	inch mm	inch mm	psi MPa
606CR-8-8C	-08	1/2	3/4 - 16UNF	3.88	2.13	1.00	5,000
	12	12.7		98.6	54.1		
606CR-16-16C	-16	1	1 5/16 - 12UNF	5.39	2.64	1.63	5,000
	25	25.4		137.0	67.0		







## Material

Stainless steel (AISI 316), other materials on request.

**2240N (V91) – polyflex® hose**



2240N (V91)

#														
	size DN	inch mm	inch mm	psi MPa	psi MPa	inch mm	lbs/ft kg/m							
2240N-04V91	-04	1/4	0.46	6,200	25,000	4.7	0.11	RX						
	6	6.4	11.7	43.0	172.5	120.0	0.17							

**Construction**

**Core tube:** Methanol washed PA11  
**Pressure reinforcement:** High strength wire  
**Cover:** PA12, black

**Applications**

Small OD, low volumetric expansion hose.  
 Long length subsea umbilical hose.

**Temperature range**

-40°C up to +100°C, max. 70°C for water or methanol based fluids.  
 -40°F up to +212°F, max. 158°F for water or methanol based fluids.  
 Consult Parker for more detailed information.

## 106RX – JIC female swivel fitting

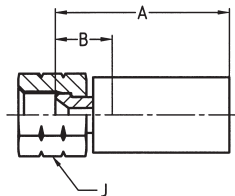

#	⊙		🌀	A	B	J	↻
	size DN	inch mm					
106RX-4-04C	-04	1/4	7/16 - 20UNF	2.24	1.02	0.75	6,200
	6	6.4		57.0	26.0	19	43.0
106RX-6-04C	-04	1/4	9/16 - 18UNF	2.17	0.94	0.75	6,200
	6	6.4		55.0	24.0	19	43.0

## Material

Stainless steel (AISI 316), other materials on request.

## 192RX – BSP female swivel fitting

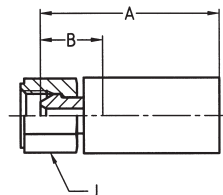

#	⊙		🌀	A	B	J	↻
	size DN	inch mm					
192RX-4-04C	-04	1/4	G 1/4	2.20	0.98	0.75	6,200
	6	6.4		56.0	25.0	19	43.0

## Material

Stainless steel (AISI 316), other materials on request.

**1C9RX – Metric swivel fitting with O-ring  
 Heavy series**

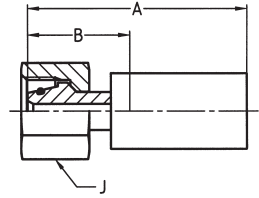

2240N (V91)

#	⊙		⌚	A	B	J	↻
	size DN	inch mm		inch mm	inch mm	inch mm	
1C9RX-8-04C	-04	1/4	M16x1.5	2.32	1.06	0.75	6,200
	6	6.4		59.0	27.0	19	43.0
1C9RX-10-04C	-04	1/4	M18x1.5	2.56	1.30	0.87	6,200
	6	6.4		65.0	33.0	22	43.0

**Material**

Stainless steel (AISI 316), other materials on request.

**2370N (V91) – polyflex® hose**

#												
	size DN	inch mm	inch mm	psi MPa	psi MPa	inch mm	lbs/ft kg/m					
2370N-06V91	-06	3/8	0.65	6,240	25,020	4.72	0.22					RX
	10	9.5	16.4	43.0	172.5	120.0	0.33					
2370N-08V91*	-08	1/2	0.79	5,080	20,300	5.91	0.28					9X
	12	12.7	20.1	35.0	140.0	150.0	0.42					

\*: consult factory

**Construction**

<b>Core tube:</b>	Methanol washed PA11
<b>Pressure reinforcement:</b>	High strength wire
<b>Cover:</b>	PA12, black

**Applications**

Small diameter, low volumetric expansion hose.  
Long length subsea umbilical hose.

**Temperature range**

-40°C up to +100°C, max. 70°C for water or methanol based fluids.  
-40°F up to +212°F, max. 158°F for water or methanol based fluids.  
Consult Parker for more detailed information.

## 106RX/1069X – JIC female swivel fitting

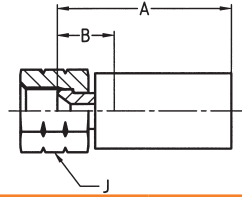

#	⊙		~~~~~	A	B	J	↻
	size DN	inch mm					
106RX-6-06C	-06	3/8	9/16 - 18UNF	1.85	0.71	0.75	6,240
	10	9.5		47.0	18.0	19	43.0
1069X-8-08C	-08	1/2	3/4 - 16UNF	2.52	0.83	1.063	5,080
	12	12.7		64.0	21.0	27	35.0

### Material

Stainless steel (AISI 316), other materials on request.

## 192RX/1929X – female swivel fitting

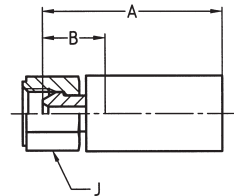

#	⊙		~~~~~	A	B	J	↻
	size DN	inch mm					
192RX-6-06C	-06	3/8	G3/8	1.89	0.75	0.75	6,240
	10	9.5		48.0	19.0	19	43.0
1929X-8-08C	-08	1/2	G1/2	2.48	0.79	1.06	5,08
	12	12.7		63.0	20.0	27	35.0

### Material

Stainless steel (AISI 316), other materials on request.

2370N (V91)

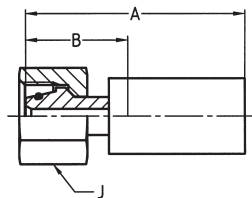
**1C9RX – Metric swivel fitting with O-ring  
Heavy series**

#	⊙		⌚	A	B	J	⊙
	size DN	inch mm					
1C9RX-12-06C	-06	3/8	M20x1.5	2.20	1.10	0.94	6,240
	10	9.5		56.0	28.0	24	43.0
1C99X-16-08C	-08	1/2	M24x1.5	3.11	1.38	1.18	5,080
	12	12.7		79.0	35.0	30	35.0







**Material**

Stainless steel (AISI 316), other materials on request.

## 2380N (V91) – *polyflex*® hose



2380N (V91)

#														
	size DN	inch mm	inch mm	psi MPa	psi MPa	inch mm	lbs/ft kg/m							
2380N-04V91	-04	1/4	0.53	10,000	40,000	2.76	0.18	LX, 8X						
	6	6.4	13.5	69.0	276.0	70.0	0.27							
2380N-06V91*	-06	3/8	0.72	7,500	30,000	7.1	0.22	8X						
	10	9.5	18.4	51.7	207.0	180.0	0.33							
2380N-08V91*	-08	1/2	0.84	7,500	30,000	7.87	0.36	8X						
	12	12.7	21.3	51.7	207.0	200.0	0.54							
2380N-20V91*	-20	1 1/4	1.73	4,000	16,000	15.75	1.23	NX						
	32	31.8	44.0	27.5	110.0	400.0	1.83							

\*: consult factory

### Construction

**Core tube:** Methanol washed PA11  
**Pressure reinforcement:** High strength wire  
**Cover:** PA12, black

### Applications

Small diameter, low volumetric expansion hose.  
 Long length subsea umbilical hose.

### Temperature range

-40°C up to +100°C, max. 70°C for water or methanol based fluids.  
 -40°F up to +212°F, max. 158°F for water or methanol based fluids.  
 Consult Parker for more detailed information.

### 1068X/106NX – JIC female swivel fitting

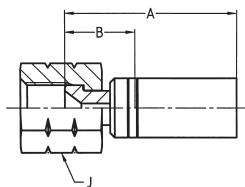

#	⊙		⌚	A	B	J	↗
	size DN	inch mm					
1068X-4-04C	-04	1/4	7/16 - 20UNF	2.24	1.02	0.75	10,000
	6	6.4		57.0	26.0	19	69.0
1068X-6-04C	-04	1/4	9/16 - 18UNF	2.17	0.94	0.75	10,000
	6	6.4		55.0	24.0	19	69.0
1068X-8-06C	-06	3/8	3/4 - 16UNF	2.32	0.75	0.94	7,500
	10	9.5		59.0	19.0	24	51.7
1068X-10-08C	-08	1/2	7/8 - 14UNF	2.44	0.75	1.06	7,500
	12	12.7		62.0	19.0	27	51.7
106NX-20-20C	-20	1 1/4	1 5/8 - 12UNF	3.50	1.10	1.97	4,000
	32	31.8		89.0	28.0	50	27.5

#### Material

Stainless steel (AISI 316), other materials on request.

### 1928X/192NX – BSP female swivel fitting

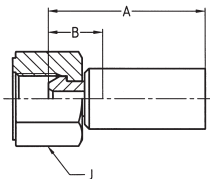

#	⊙		⌚	A	B	J	↗
	size DN	inch mm					
1928X-4-04C	-04	1/4	G 1/4	2.20	0.98	0.75	10,000
	6	6.4		56.0	25.0	19	69.0
1928X-6-06C	-06	3/8	G 3/8	2.32	0.75	0.87	7,500
	10	9.5		59.0	19.0	22	51.7
1928X-8-08C	-08	1/2	G 1/2	2.48	0.79	1.06	7,500
	12	12.7		63.0	20.0	27	51.7
192NX-24-20C	-20	1 1/4	G 1 1/4	3.58	1.18	2.36	4,000
	32	31.8		91.9	30.0	60	27.5

#### Material

Stainless steel (AISI 316), other materials on request.

2380N (V91)

## 1C98X/1C9NX – Metric swivel nut with O-ring Heavy series

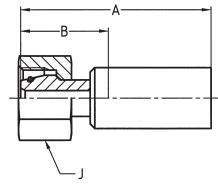

2380N (V91)

#	⊙		🌀	A	B	J	↗
	size DN	inch mm					
1C98X-8-04C	-04	1/4	M16 x 1.5	2.32	1.06	0.75	10,000
	6	6.4		59.0	27.0	19	69.0
1C98X-10-04C	-04	1/4	M18 x 1.5	2.56	1.30	0.87	10,000
	6	6.4		65.0	33.0	22	69.0
1C98X-12-06C	-06	3/8	M20 x 1.5	2.80	1.18	1.18	7,500
	10	9.5		71.0	30.0	30	51.7
1C98X-16-08C	-08	1/2	M24 x 1.5	3.07	1.38	1.18	7,500
	12	12.7		78.0	35.0	30	51.7
1C9NX-38-20C	-20	1 1/4	M52 x 2	4.45	2.05	2.36	4,000
	32	31.8		113.0	52.0	60	27.5

### Material

Stainless steel (AISI 316), other materials on request.

## 6AYLX – 59° sealing cone UNF swivel nut

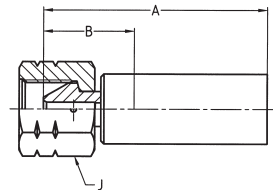

#	⊙		🌀	A	B	J	↗
	size DN	inch mm					
6AYLX-6-4C	-04	1/4	9/16 - 18UNF	2.68	1.38	0.67	10,000
	6	6.4		68.0	35.0	17	69.0
6AYLX-6-4C-SD*	-04	1/4	9/16 - 18UNF	2.56	1.30	0.75	10,000
	6	6.4		65.0	33.0	19	69.0

\*: consult factory

### Material

Nut and shell from stainless steel (AISI), other materials on request.

**2390N (V91) – polyflex® hose**

#									
	size DN	inch mm	inch mm	psi MPa	psi MPa	inch mm	lbs/ft kg/m		
2390N-06V91	-06	3/8	0.72	6,454	25,800	7.10	0.22	9X	
	10	9.5	18.4	44.5	178.0	180.0	0.33		
2390N-08V91	-08	1/2	0.84	6,019	24,100	7.87	0.36	9X	
	12	12.7	21.3	41.5	166.0	200.0	0.54		
2390N-12V91	-12	3/4	1.14	5,076	20,300	11.81	0.60	9X	
	20	19.1	29.0	35.0	140.0	300.0	0.90		
2390N-16V91	-16	1	1.38	4,061	16,200	13.39	0.91	9X	
	25	25.4	35.0	28.0	112.0	340.0	1.35		

2390N (V91)

**Construction**

Core tube:	Methanol washed PA11
Pressure reinforcement:	High strength wire
Cover:	PA12, black

**Applications**

Low volumetric expansion hose.  
Used in subsea umbilicals, hydraulic controls and as long length methanol injection hose.

**Temperature range**

-40°C up to +100°C, max. 70°C for water or methanol based fluids.  
-40°F up to +212°F, max. 158°F for water or methanol based fluids.  
Consult Parker for more detailed information.

## 1069X – JIC female swivel fitting

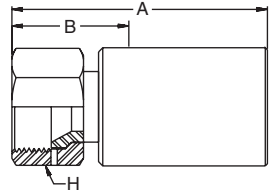

#	⊙		🌀	A	B	H	↗
	size DN	inch mm					
1069X-8-06C	-06	3/8	3/4 - 16UNF	2.32	0.75	0.94	10,000
	10	9.5		59.0	19.0	24	69.0
1069X-8-08C	-08	1/2	3/4 - 16UNF	2.52	0.83	1.06	10,000
	12	12.7		64.0	21.0	27	69.0
E213JFC4*	-08	1/2	3/4 - 16UNF	3.35	1.61	0.94	10,000
	12	12.7		85.0	41.0	24	69.0
1069X-12-12C	-12	3/4	1 1/16 - 12UNF	3.11	1.10	1.42	8,100
	20	19.0		79.0	28.0	36	56.0
E225JIC3*	-16	1	1 5/16 - 12UNF	4.29	2.09	1.61	6,500
	25	25.4		109.0	53.0	41	45.0

\*: SubSea fittings

### Material

Stainless steel (AISI 316), other materials on request.

## 1929X – BSP female swivel fitting

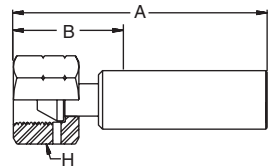

#	⊙		🌀	A	B	H	↗
	size DN	inch mm					
1929X-6-06C	-06	3/8	G 3/8	2.32	0.75	0.87	16,200
	10	9.5		59.0	19.0	22	112.0
1929X-8-08C	-08	1/2	G 1/2	2.48	0.79	1.06	16,400
	12	12.7		63.0	20.0	27	113.0
1929X-12-12C	-12	3/4	G 3/4	3.03	1.02	1.26	16,500
	20	19.0		77.0	26.0	32	114.0
1929X-16-16C	-16	1	G 1	3.46	1.06	1.61	16,700
	25	25.4		88.0	27.0	41	115.0

### Material

Stainless steel (AISI 316), other materials on request.

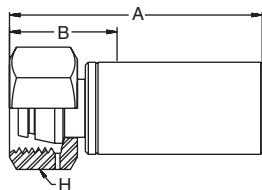
**1C99X – Metric swivel nut with O-ring  
Heavy series**

#	⊙		⌚	A	B	H	↗
	size DN	inch mm					
1C99X-12-06C	-06	3/8	M20 x 1.5	2.80	1.18	1.18	16,200
	10	9.5		71.0	30.0	30	112.0
1C99X-16-08C	-08	1/2	M24 x 1.5	3.07	1.38	1.18	16,400
	12	12.7		78.0	35.0	30	113.0
1C99X-25-12C	-12	3/4	M36 x 2	3.11	1.77	1.81	16,500
	20	19.0		79.0	45.0	46	114.0
1C99X-30-16C	-16	1	M42 x 2	3.86	1.85	1.97	16,700
	25	25.4		98.0	47.0	50	115.0

**Material**

Stainless steel (AISI 316), other materials on request.

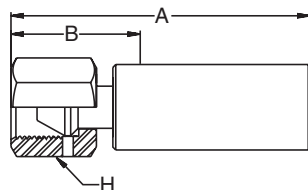
**6AY9X – Type “M”**

#	⊙		⌚	A	B	H	↗
	size DN	inch mm					
6AY9X-8-6C	-06	3/8	3/4 - 16UNF	2.80	1.18	0.98	10,300
	10	9.5		71.0	30.0	25	71.0
6AY9X-11-8C	-08	1/2	1 - 12UNF	3.19	1.50	1.26	10,300
	12	12.7		81.0	38.0	32	71.0
6AY9X-16-12C	-12	3/4	1 5/16 - 12UNF	4.13	1.54	1.50	8,100
	20	19.0		105.0	39.0	38	56.0
6AY9X-16-16C	-16	1	1 5/16 - 12UNF	3.78	1.65	1.50	6,500
	25	25.4		96.0	42.0	38	45.0







**Material**

Stainless steel (AISI 316), other materials on request.

## 2440N (V91) – *polyflex*® hose



2440N (V91)

#														
	size DN	inch mm	inch mm	psi MPa	psi MPa	inch mm	lbs/ft kg/m							
2440N-04V91	-04	1/4	0.52	12,700	50,800	6.00	0.21	LX						
	6	6.4	13.2	87.5	350.0	150.0	0.31							
2440N-06V91	-06	3/8	0.77	12,700	50,800	7.50	0.50	LX						
	10	9.5	19.6	87.5	350.0	190.0	0.74							
2440N-08V91	-08	1/2	0.90	11,700	47,100	7.90	0.63	LX						
	12	12.7	22.9	81.0	325.0	200.0	0.94							
2440N-12V91	-12	3/4	1.20	9,100	36,300	9.80	0.98	LX						
	20	19.1	30.4	63.0	250.0	250.0	1.46							
2440N-16V91	-16	1	1.47	8,120	32,600	11.80	1.34	LX						
	25	25.4	37.4	56.0	225.0	300.0	2.00							

### Construction

**Core tube:** Methanol washed PA11  
**Pressure reinforcement:** High strength wire  
**Cover:** PA12, black

### Applications

Long length subsea umbilical hose.

### Temperature range

-40°C up to +100°C, max. 70°C for water or methanol based fluids.  
 -40°F up to +212°F, max. 158°F for water or methanol based fluids.  
 Consult Parker for more detailed information.

## 106LX – JIC female swivel fitting

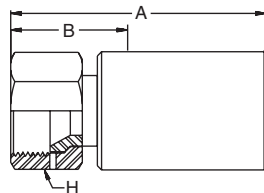

#	⊙		⌚	A	B	⬡	⦿
	size DN	inch mm					
106LX-6-04C	-04	1/4	9/16 - 18UNF	2.17	0.91	0.75	12,700
	6	6.4		55.0	23.0	19	87.5
106LX-6-06C	-06	3/8	9/16 - 18UNF	2.32	0.71	0.87	12,700
	10	9.5		59.0	18.0	22	87.5
106LX-8-06C	-06	3/8	3/4 - 16UNF	2.32	0.75	0.94	12,700
	10	9.5		59.0	19.0	24	87.5
106LX-8-08C	-08	1/2	3/4 - 16UNF	2.52	0.83	1.06	11,700
	12	12.7		64.0	21.0	27	81.0
106LX-10-08C	-08	1/2	1 - 12UNF	3.35	1.61	0.94	11,700
	12	12.7		85.0	41	24	81.0
106LX-16-12C	-12	3/4	1 5/16 - 12UNF	4.29	1.69	1.61	9,100
	20	19.0		109.0	43.0	41	63.0
106LX-16-16C*	-16	1	1 5/16 - 12UNF	3.78	1.65	1.61	8,100
	25	25.4		96.0	42.0	41	56.0

## Material

Stainless steel (AISI 316), other materials on request.

\*Nipple made from high strength steel.

**1C9LX – Metric swivel with O-ring  
 Heavy series**

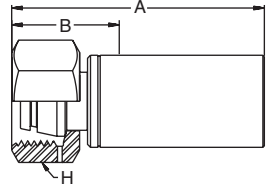

2440N (V91)

#	⊙		⌚	A	B	⬡	↻
	size DN	inch mm					
1C9LX-10-04C	-04	1/4	M18 x 1.5	2.76	1.30	0.87	12,700
	6	6.4		70.0	33.0	22	87.5
1C9LX-14-06C	-06	3/8	M22 x 1.5	2.99	1.18	1.18	12,700
	10	9.5		76.0	30.0	30	87.5
1C9LX-16-08C	-08	1/2	M24 x 1.5	3.46	1.34	1.26	11,700
	12	12.7		88.0	34.0	32	81.0
1C9LX-25-12C	-12	3/4	M36 x 2	4.25	1.57	1.81	9,100
	20	19.0		108.0	40.0	46	63.0
1C9LX-30-16C*	-16	1	M42 x 2	5.47	1.77	2.17	8,100
	25	25.4		139.0	45.0	55	56.0

**Material**

Stainless steel (AISI 316), other materials on request.  
 \*Nipple made from high strength steel.

## 6AYLX – Type “M”

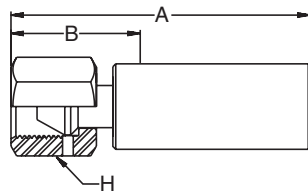

#	⊙		🌀	A	B	⬡	↗
	size DN	inch mm					
6AYLX-6-4C	-04	1/4	9/16 - 18UNF	2.68	1.38	0.67	12,700
	6	6.4		68.0	35.0	17	87.5
6AYLX-6-4C-SD*	-04	1/4	9/16 - 18UNF	2.68	1.38	0.67	12,700
	6	6.4		68.0	35.0	17	87.5
6AYLX-8-6C	-06	3/8	3/4 - 16UNF	2.95	1.26	0.98	11,700
	10	9.5		75.0	32.0	25	81.0
6AYLX-11-8C	-08	1/2	1 - 12UNF	3.54	1.50	1.26	11,700
	12	12.7		90.0	38.0	32	81.0
6AYLX-11-8C-SD*	-08	1/2	1 - 12UNF	3.54	1.50	1.26	9,100
	12	12.7		90.0	38.0	32	63.0
6AYLX-16-12C	-12	3/4	1 5/16 - 12UNF	4.13	1.54	1.50	9,100
	20	19.0		105.0	39.0	38	63.0
6AYLX-16-12C-SD*	-12	3/4	1 5/16 - 12UNF	4.29	1.65	1.50	9,100
	20	19.0		109.0	42.0	38	63.0
6AYLX-16-16C	-16	1	1 5/16 - 12UNF	5.47	2.05	1.50	8,100
	25	25.4		139.0	52.0	38	56.0
6AYLX-16-16C-SD*	-16	1	1 5/16 - 12UNF	5.47	2.05	1.50	8,100
	25	25.4		139.0	52.0	38	56.0

2440N (V91)

## Material







Nipple made from high strength steel, nut and shell stainless steel (AISI 316), other materials on request.

\*: Nipple made from high corrosion resistant steel, nut and shell stainless steel (AISI 316).

**2448N (V91) – polyflex® hose**



2448N (V91)

#														
	size DN	inch mm	inch mm	psi MPa	psi MPa	inch mm	lbs/ft kg/m							
2448N-04V91	-04	1/4	0.54	15,000	60,000	5.91	0.57	8X						
	6	6.4	13.8	103.5	414.0	150.0	0.38							
2448N-06V91*	-06	3/8	0.80	15,000	60,000	7.50	1.10							
	10	9.5	20.3	103.5	414.0	190.0	0.74							

\*: consult factory

**Construction**

**Core tube:** Methanol washed PA11  
**Pressure reinforcement:** High strength wire  
**Cover:** PA12, black

**Applications**

Long length subsea umbilical hose.

**Temperature range**

-40°C up to +100°C, max. 70°C for water or methanol based fluids.  
 -40°F up to +212°F, max. 158°F for water or methanol based fluids.  
 Consult Parker for more detailed information.

## 1AY8X – Type “M”

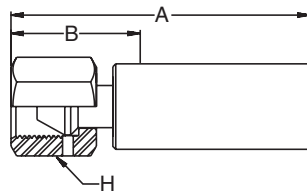

#	⊙		⌚	A	B	⬡	↗
	size DN	inch mm		inch mm	inch mm	inch mm	
1AY8X-6-04C	-04	1/4	9/16 - 18UNF	2.68	1.38	0.67	15,000
	6	6.4		68.0	35.0	17	103.5

## Material

Stainless steel (AISI 316), other materials on request.

## 1Y28X – Medium pressure tube nipple

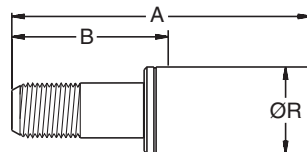

#	⊙		⌚	A	B	ØR	↗
	size DN	inch mm		inch mm	inch mm	inch mm	
1Y28X-6-04C	-04	1/4	3/8 - 24 LH	4.29	2.20	0.87	15,000
	6	6.4		109.0	56.0	22	103.5







## Material

Stainless steel (AISI 316), other materials on request.

## 2640N (V91) – **polyflex**<sup>®</sup> hose



2640N (V91)

#									
	size DN	inch mm	inch mm	psi MPa	psi MPa	inch mm	lbs/ft kg/m		
2640N-08V91*	-08	1/2	0.98	16,400	65,270	11.40	0.94	5X	
	12	12.7	24.8	113.0	450.0	290.0	1.40		
2640N-12V91*	-12	3/4	1.31	12,760	50,760	13.80	1.45	5X	
	20	19.1	33.2	88.0	350.0	350.0	2.16		
2640N-16V91*	-16	1	1.59	10,880	43,510	15.80	1.91	5X	
	25	25.4	40.4	75.0	300.0	400.0	2.84		

\*: consult factory

### Construction

**Core tube:** Methanol washed PA11  
**Pressure reinforcement:** High strength wire  
**Cover:** PA12, black

### Applications

Ultra high pressure umbilical hose.

### Temperature range

-40°C up to +100°C, max. 70°C for water or methanol based fluids.  
 -40°F up to +212°F, max. 158°F for water or methanol based fluids.  
 Consult Parker for more detailed information.

### Remarks

\* Consult factory

**6AY5X – Type “M”**

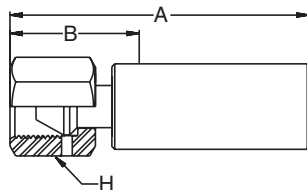

#	⊙		🌀	A	B	⊠	↗
	size DN	inch mm					
6AY5X-11-8C	-08	1/2	1 - 12UNF	4.25	1.73	1.26	16,400
	12	12.7		108.0	44.0	32	113.0
6AY5X-16-12C	-12	3/4	3/4 - 14NPTF	4.25	1.54	1.50	12,800
	20	19.0		108.0	39.0	38	88.0
6AY5X-16-12C-SD*	-12	3/4	3/4 - 14NPTF	4.25	1.54	1.50	12,800
	20	19.0		108.0	39.0	38	88.0
6AY5X-16-16C	-16	1	1 - 1 1/2NPTF	5.47	2.05	1.50	10,900
	25	25.4		139.0	52.0	38	75.0
6AY5X-16-16C-SD*	-16	1	1 - 1 1/2NPTF	5.47	2.05	1.50	10,900
	25	25.4		139.0	52.0	38	75.0

2640N (V91)

**Material**

Stainless steel (AISI 316), other materials on request.

\*: SubSea fittings; nipple made from high corrosion resistant steel, nut and shell stainless steel (AISI 316).

**6Y25X – Medium pressure tube nipple**

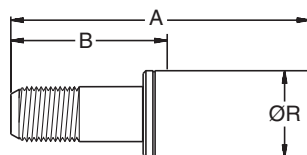

#	⊙		🌀	A	B	ØR	↗
	size DN	inch mm					
6Y25X-9-8C	-08	1/2	9/16 - 18 LH	4.29	2.20	1.26	16,400
	12	12.7		109.0	56.0	32.0	113.0
6Y25X-12-8C	-08	1/2	3/4 - 16 LH	4.21	2.09	1.26	16,400
	12	12.7		107.0	53.0	32.0	113.0
6Y25X-16-12C	-12	3/4	1 - 14 LH	5.47	2.76	1.69	12,800
	20	19.0		139.0	70.0	43.0	88.0

**Material**

Stainless steel (AISI 316), other materials on request.

**6C95X – Metric swivel nut with O-ring**  
**Heavy series**

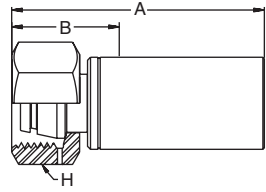







2640N (V91)

#	⊙		🌀	A	B	H	↗
	size DN	inch mm		inch mm	inch mm	inch mm	psi MPa
6C95X-16-08C	-08	1/2	M24 x 1.5	3.58	1.46	1.26	16,400
	12	12.7		91.0	37.0	32	113.0
6C95X-25-12C	-12	3/4	M36 x 2	4.37	1.61	1.81	12,800
	20	19.0		111.0	41.0	46	88.0
6C95X-30-16C	-16	1	M42 x 2	4.76	2.17	1.97	10,900
	25	25.4		121.0	55.0	50	75.0

**Material**

Stainless steel (AISI 316), other materials on request.

**2240M (V30) – polyflex® hose**  
**ChemJec**

#												
	size DN	inch mm	inch mm	psi MPa	psi MPa	inch mm	lbs/ft kg/m					
2240M-04V30	-04	1/4	0.46	6,200	25,000	4.70	0.11					
	6	6.4	11.7	43.0	172.5	120.0	0.17					RX

**Construction**

<b>Core tube:</b>	Flouropolymer based
<b>Pressure reinforcement:</b>	High strength wire
<b>Cover:</b>	PA12, black

**Applications**

Medium pressure, high temperature, low volumetric expansion hose. Excellent chemical resistance.  
Long length subsea umbilical hose.

**Temperature range**

-40°C up to +100°C, short term 125°C  
-40°F up to +212°F, short term 257°F  
Consult Parker for more detailed information.

2240M (V30)

## 106RX – JIC female swivel fitting

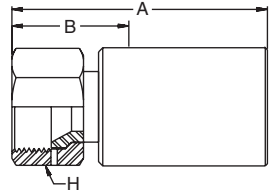

#	⊙		🌀	A	B	⬡	↗
	size DN	inch mm		inch mm	inch mm	inch mm	
106RX-4-04C	-04	1/4	7/16 - 20UNF	2.24	1.02	0.75	6,200
	6	6.4		57.0	26.0	19	43.0
106RX-6-04C	-04	1/4	9/16 - 18UNF	2.17	0.94	0.75	6,200
	6	6.4		55.0	24.0	19	43.0

### Material

Stainless steel (AISI 316), other materials on request.

## 192RX – BSP female swivel fitting

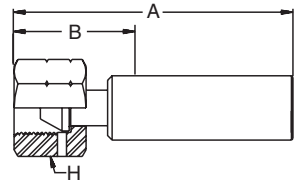

#	⊙		🌀	A	B	⬡	↗
	size DN	inch mm		inch mm	inch mm	inch mm	
192RX-4-04C	-04	1/4	G 1/4	2.20	0.98	0.75	6,200
	6	6.4		56.0	25.0	19	43.0

### Material

Stainless steel (AISI 316), other materials on request.

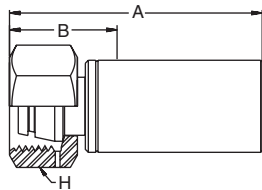
**1C9RX – Metric swivel fitting with O-ring  
Heavy series**

#	⊙		⌚	A	B	⬡	⊙ ↗
	size DN	inch mm					
1C9RX-8-04C	-04	1/4	M16 x 1.5	2.32	1.06	0.75	6,200
	6	6.4		59.0	27.0	19	43.0
1C9RX-10-04C	-04	1/4	M18 x 1.5	2.56	1.30	0.87	6,200
	6	6.4		65.0	33.0	22	43.0

**Material**

Stainless steel (AISI 316), other materials on request.

**2370M (V30) – polyflex® hose**  
**ChemJec**



2370M (V30)

#									
	size DN	inch mm	inch mm	psi MPa	psi MPa	inch mm	lbs/ft kg/m		
2370M-06V30	-06	3/8	0.65	6,237	25,019	4.72	0.22	RX	
	10	9.5	16.6	43.0	172.5	120.0	0.33		
2370M-08V30*	-08	1/2	0.79	5,076	20,305	5.91	0.28	RX	
	12	12.7	20.10	35.0	140.0	150.0	0.42		

\*: consult factory

**Construction**

**Core tube:** Fluoropolymer based  
**Pressure reinforcement:** High strength wire  
**Cover:** PA12, black

**Applications**

Medium pressure, high temperature, low volumetric expansion hose. Excellent chemical resistance.  
 Long length subsea umbilical hose.

**Temperature range**

-40°C up to +100°C, short term 125°C  
 -40°F up to +212°F, short term 257°F  
 Consult Parker for more detailed information.

## 106RX – JIC female swivel fitting

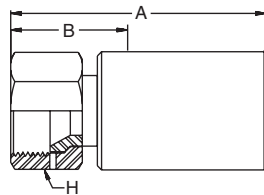

#	⊙		⌚	A	B	H	↗
	size DN	inch mm		inch mm	inch mm	inch mm	
106RX-6-06C	-06 10	3/8 9.5	9/16 - 18UNF	1.85 47.0	0.71 18.0	0.75 19	6,200 43.0

## Material

Stainless steel (AISI 316), other materials on request.

## 192RX – BSP female swivel fitting

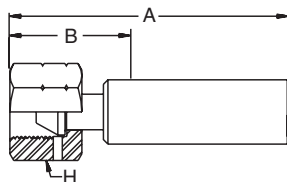



#	⊙		⌚	A	B	H	↗
	size DN	inch mm		inch mm	inch mm	inch mm	
192RX-6-06C	-06 10	3/8 9.5	G 3/8	1.89 48.0	0.75 19.0	0.87 22	6,200 43.0

## Material

Stainless steel (AISI 316), other materials on request.

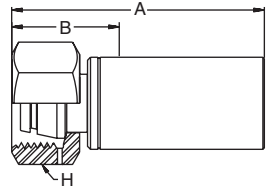
**1C9RX – Metric swivel nut with O-ring  
 Heavy series**









#	⊙			A	B	H	
	size DN	inch mm		inch mm	inch mm	inch mm	psi MPa
1C9RX-12-06C	-06	3/8	M20 x 1.5	2.20	1.10	0.94	6,200
	10	9.5		56.0	28.0	24	43.0

**Material**

Stainless steel (AISI 316), other materials on request.

2370M (V30)

**2380M (V30) – polyflex® hose**  
**ChemJec**

#														
	size DN	inch mm	inch mm	psi MPa	psi MPa	inch mm	lbs/ft kg/m							
2380M-04V30	-04	1/4	0.53	10,000	40,610	2.76	0.18	LX						
	6	6.4	13.5	69.0	280.0	70.0	0.27							

2380M (V30)

**Construction**

Core tube:	Flouropolymer based
Pressure reinforcement:	High strength wire
Cover:	PA12, black

**Applications**

High pressure, high temperature, low volumetric expansion hose.  
Excellent chemical resistance.  
Long length subsea umbilical hose.

**Temperature range**

-40°C up to +100°C, short term 125°C  
-40°F up to +212°F, short term 257°F  
Consult Parker for more detailed information.

## 6AYLX – Type “M” female swivel fitting

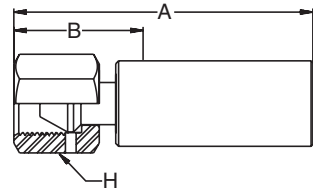

#	⊙		~~~~~	A	B	H	↻
	size DN	inch mm		inch mm	inch mm	inch mm	
6AYLX-6-4C-M-Subsea	-04	1/4	9/16 - 18UNF	2.56	1.30	0.75	10,000
	6	6.4		65.0	33.0	19	

### Material

Nipple made from high strength, high corrosion resistant steel, nut and shell stainless steel (AISI 316).

## 606LX – JIC female swivel fitting

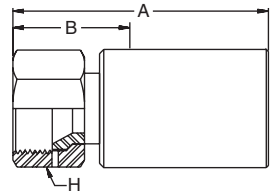

#	⊙		~~~~~	A	B	H	↻
	size DN	inch mm		inch mm	inch mm	inch mm	
606LX-6-4C-M-Subsea	-04	1/4	9/16 - 18UNF	2.36	1.10	0.67	10,000
	6	6.4		60.0	28.0	17	

### Material

Nipple made from high strength, high corrosion resistant steel, nut and shell stainless steel (AISI 316).

## 692LX – BSP female swivel fitting

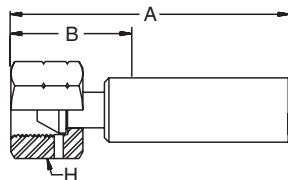

#	⊙		~~~~~	A	B	H	↻
	size DN	inch mm					
692LX-4-4C-M-Subsea*	-04	1/4	G 1/4	2.20	0.98	0.75	10,000
	6	6.4		56.0	25.0	19	69.0

\*: consult factory

**Material**

Nipple made from high strength, high corrosion resistant steel, nut and shell stainless steel (AISI 316).

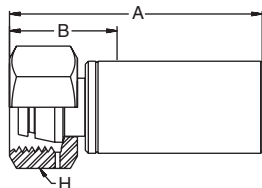
6C9LX – Metric swivel nut with O-ring  
Heavy series

#	⊙		~~~~~	A	B	H	↻
	size DN	inch mm					
6C9LX-8-4C-M-Subsea*	-04	1/4	M16 x 1.5	2.32	1.06	0.75	10,000
	6	6.4		59.0	27.0	19	69.0
6C9LX-10-4C-M-Subsea*	-04	1/4	M18 x 1.5	2.56	1.30	0.87	10,000
	6	6.4		65.0	33.0	22	69.0

\*: consult factory

**Material**

Nipple made from high strength, high corrosion resistant steel, nut and shell stainless steel (AISI 316).

## 6Y2LX/1Y2LX – Medium pressure tube nipple

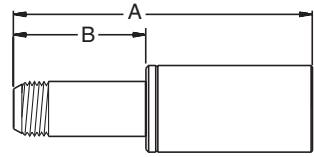





#	⊙		~~~~~	A	B	↗
	size DN	inch mm		inch mm	inch mm	
6Y2LX-6-4C-M-Subsea	-04	1/4	3/8 - 24 UNF	5.20	3.20	10,000
	6	6.4		132.0	80.0	
1Y2LX-6-04M-INC625	-04	1/4	3/8 - 24 UNF	5.20	3.20	10,000
	6	6.4		132.0	80.0	

### Material

Stainless steel (AISI 316), nipple made from super duplex, other materials on request.

2380M (V30)

**2440M (V30) – polyflex® hose**  
**ChemJec**

#									
	size DN	inch mm	inch mm	psi MPa	psi MPa	inch mm	lbs/ft kg/m		
2440M-04V30	-04	1/4	0.52	12,691	50,762	6.10	0.21	LX	
	6	6.4	13.2	87.5	350.0	155.0	0.31		
2440M-05V30	-05	5/16	0.64	10,000	40,000	6.90	0.33	LX	
	8	7.9	16.3	69.0	276.0	175.0	0.49		
2440M-06V30*	-06	3/8	0.77	12,691	50,762	7.48	0.50	LX	
	10	9.5	19.6	87.5	350.0	190.0	0.74		
2440M-08V30*	-08	1/2	0.90	11,748	47,136	7.87	0.63	LX	
	12	12.7	22.8	81.0	325.0	200.0	0.94		

\*: consult factory

**Construction**

**Core tube:** Fluoropolymer based  
**Pressure reinforcement:** High strength wire  
**Cover:** PA12, black

**Applications**

Long length subsea umbilical hose.

**Temperature range**

-40°C up to +100°C, short term 125°C  
 -40°F up to +212°F, short term 257°F  
 Consult Parker for more detailed information.

## 106LX – JIC female swivel fitting

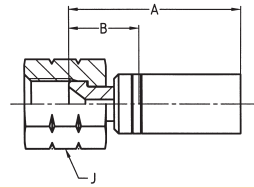

#	⊙		🌀	A	B	⬡	↻
	size DN	inch mm		inch mm	inch mm	inch mm	
106LX-6-04C	-04	1/4	9/16 - 18UNF	2.17	0.91	0.75	12,700
	6	6.4		55.0	23.0	19	
106LX-6-06C-M-Subsea*	-06	3/8	9/16 - 18UNF	2.32	0.71	0.87	12,700
	10	9.5		59.0	18.0	22	
106LX-8-06C-M-Subsea*	-06	3/8	3/4 - 16UNF	2.32	0.75	0.94	12,700
	10	9.5		59.0	19.0	24	
106LX-8-08C-M-Subsea*	-08	1/2	3/4 - 16UNF	2.52	0.83	1.06	11,700
	12	12.7		64.0	21.0	27	

\*: consult factory

### Material

Stainless steel (AISI 316), other materials on request.

## 1C9LX/606LX – Metric swivel with O-ring Heavy series

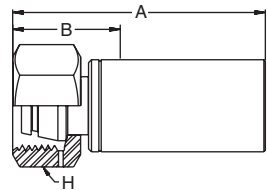

#	⊙		🌀	A	B	⬡	↻
	size DN	inch mm		inch mm	inch mm	inch mm	
1C9LX-10-04C	-04	1/4	M18 x 1.5	2.76	1.30	0.87	12,700
	6	6.4		70.0	33.0	22	
1C9LX-14-06C-M-Subsea*	-06	3/8	M22 x 1.5	2.99	1.18	1.18	12,700
	10	9.5		76.0	30.0	30	
1C9LX-16-08C-M-Subsea*	-08	1/2	M24 x 1.5	3.46	1.34	1.26	11,700
	12	12.7		88.0	34.0	32	

\*: consult factory

### Material

Stainless steel (AISI 316), other materials on request.

**2448M (V30) – polyflex® hose**  
**ChemJec**

#										
	size DN	inch mm	inch mm	psi MPa	psi MPa	inch mm	lbs/ft kg/m			
2448M-04V30	-04	1/4	0.54	15,000	60,000	6.30	0.26	UX		
	6	6.4	13.8	103.5	414.0	160.0	0.38			
2448M-05V30	-05	5/16	0.64	15,000	60,000	7.09	0.39	UX		
	8	7.9	16.3	103.5	414.0	180.0	0.58			
2448M-06V30*	-06	3/8	0.80	15,000	60,000	7.87	0.58	UX		
	10	9.5	20.4	103.5	414.0	200.0	0.86			

2448M (V30)

\*: consult factory

**Construction**

**Core tube:** Fluoropolymer based  
**Pressure reinforcement:** High strength wire  
**Cover:** PA12, black

**Applications**

Long length subsea umbilical hose.

**Temperature range**

-40°C up to +100°C, short term 125°C  
 -40°F up to +212°F, short term 257°F  
 Consult Parker for more detailed information.

## 1AYUX – Type “M”

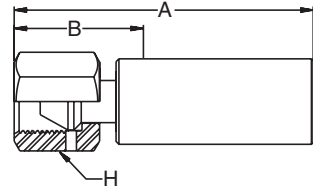

#	⊙		🌀	A	B	⬡	↗
	size DN	inch mm		inch mm	inch mm	inch mm	psi MPa
1AYUX-6-04C	-04	1/4	9/16 - 18UNF	3.66	1.38	0.67	15,000
	6	6.4		93.0	35.0		
1AYUX-8-05C	-05	5/19	3/4 - 16UNF	3.94	1.38	1.06	15,000
	8	7.9		100.0	35.0		
1AYUX-8-06C*	-06	3/8	3/4 - 16UNF	3.94	1.38	1.06	15,000
	10	9.5		100.0	35.0		

\*: consult factory

### Material

Stainless steel (AISI 316), other materials on request.

## 1Y2UX – Medium pressure tube nipple

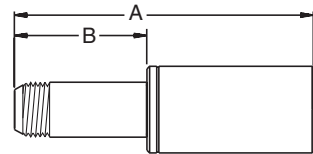

#	⊙		🌀	A	B	↗
	size DN	inch mm		inch mm	inch mm	psi MPa
1Y2UX-6-04C	-04	1/4	3/8 - 24 UNF-LH	4.29	2.20	15,000
	6	6.4		109.0	56.0	
1Y2UX-6-05C	-05	5/16	9/16 - 18 UNF-LH	4.84	2.24	15,000
	8	7.9		123.0	57.0	
1Y2UX-9-06C*	-06	3/8	9/16 - 18 UNF-LH	4.84	2.24	15,000
	10	9.5		123.0	57.0	

\*: consult factory

### Material

Stainless steel (AISI 316), nipple made from super duplex, other materials on request.

2448M (V30)

---

**Chapter C****BOP and hot-line hoses**

<b>Textile reinforced hoses and related fittings .....</b>	<b>C-2</b>
<b>573LH</b> – Low volumetric expansion BOP hose .....	C-2
<b>575LH</b> – Low volumetric expansion BOP hose .....	C-2
<b>575X</b> – Low volumetric expansion BOP hose .....	C-2
<b>H580N</b> – Low volumetric expansion BOP hose .....	C-2
<b>Wire reinforced hoses and related fittings.....</b>	<b>C-4</b>
<b>2390N</b> – <b>polyflex</b> <sup>®</sup> hot-line hose .....	C-4
<b>593</b> – High pressure hose.....	C-7

## 573LH, 575LH, 575X, H580N – Low volumetric expansion BOP hose



573LH, 575LH

#	○		○	○	✂	↷	⊥	Series
	size DN	inch mm	inch mm	psi MPa	psi MPa	inch mm	lbs/ft kg/m	
573LH-3	-03	3/16	0.35	3,000	12,000	1.50	0.036	LV
	5	4.8	8.9	20.7	82.8	38.0	0.05	
575LH-3	-03	3/16	0.38	5,000	20,000	1.50	0.043	LH
	5	4.8	9.7	34.5	138.0	38.0	0.06	
575X-16	-16	1	1.59	5,000	20,000	10.00	0.360	58H
	25	25.4	40.3	34.5	138.0	254.0	0.53	
H580N-16	-16	1.02	1.57	3,000	12,000	10.00	0.530	58H
	25	25.8	39.9	20.7	82.8	254.0	0.78	

### Construction

- Core tube:** Polyamide
- Pressure reinforcement:** One or two braided layers of high tensile aramid fibres
- Cover:** Special polyurethane, black

### Applications

High pressure service for use with petroleum or synthetic hydraulic fluids for BOP umbilical applications where low volumetric expansion is required.

### Temperature range

-40°C up to +100°C for petroleum and synthetic hydraulic fluids

### Change in length

max. ±2 % at working pressure

**106LV, 106LH, 10658H – JIC female swivel fitting**

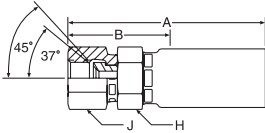

#	⊙		⌚	A	B	⬡	⦿
	size DN	inch mm					
<b>106LV-4-3C</b>	-04	1/4	7/16 - 20UNF	1.93	0.94	0.56	3,000
	6	6.4		49.0	24.0		
<b>106LH-4-3C</b>	-04	1/4	7/16 - 20UNF	1.93	0.94	0.56	5,000
	6	6.4		49.0	24.0		
<b>10658H-16-16C</b>	-16	1	1 5/16 - 12UNF	4.89	1.94	1.75	5,000
	25	25.4		124.0	49.0		

**Material**

Stainless Steel (AISI 316)

573LH, 575LH

## 2390N – **polyflex**® hot-line hose



2390N

#	○		◎	↗	↗	✂	↷	kg	□
	size DN	inch mm	inch mm	psi * MPa	psi ** MPa	psi MPa	inch mm	lbs/ft kg/m	
2390N-08V12	-08	1/2	0.84	9,570	6,020	24,080	7.87	0.36	9X
	12	12.7	21.3	66.0	41.5	166.0	200.0	0.54	
2390N-08V13	-08	1/2	0.84	9,570	6,020	24,080	7.87	0.36	9X
	12	12.7	21.3	66.0	41.5	166.0	200.0	0.54	
2390N-08V16	-08	1/2	0.84	9,570	6,020	24,080	7.87	0.36	9X
	12	12.7	21.3	66.0	41.5	166.0	200.0	0.54	
2390N-08V91	-08	1/2	0.84	9,570	6,020	24,080	7.87	0.36	9X
	12	12.7	21.3	66.0	41.5	166.0	200.0	0.54	
2390N-12V03	-12	3/4	1.15	8,120	5,080	20,300	11.81	0.60	9X
	20	19.0	29.1	56.0	35.0	140.0	300.0	0.90	
2390N-12V91	-12	3/4	1.15	8,120	5,080	20,300	11.81	0.60	9X
	20	19.0	29.1	56.0	35.0	140.0	300.0	0.90	
2390N-16V12	-16	1	1.38	6,530	4,060	16,240	13.39	0.91	9X
	25	25.4	35.1	45.0	28.0	112.0	340.0	1.35	
2390N-16V16	-16	1	1.38	6,530	4,060	16,240	13.39	0.91	9X
	25	25.4	35.1	45.0	28.0	112.0	340.0	1.35	
2390N-16V91	-16	1	1.38	6,530	4,060	16,240	13.39	0.91	9X
	25	25.4	35.1	45.0	28.0	112.0	340.0	1.35	

\* Max. working pressure with 2.5:1 safety factor

\*\* Max. working pressure with 4:1 safety factor

### Construction

**Core tube:** V12, V03, V13, V16: Polyamide; V91: PA 11 methanol washed  
**Pressure reinforcement:** High strength wire  
**Cover:** V12, V03, V13, V16: Polyurethane; V91: PA 12  
 V12: blue, V03, V13: green, V16: yellow, V91: black

### Applications

Low volumetric expansion hose. Used for subsea hydraulic controls and as long length hot-line hose for BOP systems.

### Temperature range

At 4:1 safety factor: -40°C up to +100°C, max. 70°C for water or methanol based fluids.  
 -40°F up to +212°F, max. 158°F for water or methanol based fluids.  
 At 2.5:1 safety factor: -40°C up to +60°C  
 -40°F up to +140°F  
 Consult Parker for more detailed information.

## 1069X – JIC female swivel fitting

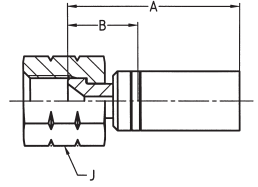

#	⊙		⌚	A	B	J	↗
	size DN	inch mm					
1069X-8-08C	-08	1/2	3/4 - 16UNF	2.52	0.83	1.063	9,570
	12	12.7		64.0	21.0	27	66.0
E213JFC4*	-08	1/2	3/4 - 16UNF	3.35	1.61	0.945	9,570
	12	12.7		85.0	41.0	24	66.0
1069X-12-12C	-12	3/4	1 1/16 - 12UNF	3.11	1.10	1.417	8,120
	20	19.0		79.0	28.0	36	56.0
1069X-16-16C	-16	1	1 5/16 - 12UNF	4.06	1.77	1.614	6,530
	25	25.4		103.0	45.0	41	45.0
E225JIC3*	-16	1	1 5/16 - 12UNF	4.30	2.10	1.614	6,530
	25	25.4		109.0	53.0	41	45.0

2390N

## Material

Stainless steel (AISI 316)

\*: Welded SubSea fitting

## 1929X – BSP female swivel fitting

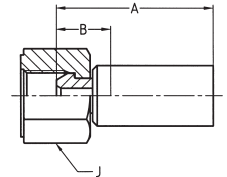

#	⊙		⌚	A	B	J	↗
	size DN	inch mm					
1929X-8-8C	-08	1/2	G 1/2	2.48	0.79	1.06	9,570
	12	12.7		63.0	20.0	27	66.0
1929X-12-12C	-12	3/4	G 3/4	3.03	1.02	1.26	8,120
	20	19.0		77.0	26.0	32	56.0
1929X-16-16C	-16	1	G 1	3.46	1.06	1.61	6,530
	25	25.4		88.0	27.0	41	45.0

## Material

Stainless steel (AISI 316)

## 1C99X – Metric swivel fitting with O-ring Heavy series

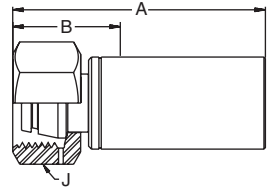

#	⊙		~~~~~	A	B	⬡	↻
	size DN	inch mm					
1C99X-16-8C	-08	1/2	M24 x 1.5	3.07	1.38	1.18	9,570
	12	12.7		78.0	35.0	30	66.0
1C99X-25-12C	-12	3/4	M36 x 2	3.11	1.77	1.81	8,120
	20	19.0		79.0	45.0	46	56.0
1C99X-30-16C	-16	1	M42 x 2	3.86	1.85	1.97	6,530
	25	25.4		98.0	47.0	50	45.0

### Material

Stainless steel (AISI 316)

## 1AY9X/6AY9X – Type "M"

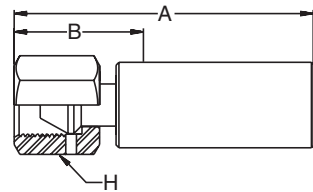







#	⊙		~~~~~	A	B	⬡	↻
	size DN	inch mm					
6AY9X-11-8C	-08	1/2	1 - 12UNF	3.19	1.50	1.26	9,570
	12	12.7		81.0	38.0	32	66.0
6AY9X-16-12C	-12	3/4	1 5/16 - 12UNF	4.13	1.54	1.50	8,120
	20	19.0		105.0	39.0	38	56.0
6AY9X-16-16C	-16	1	1 5/16 - 12UNF	3.78	1.65	1.50	6,530
	25	25.4		96.0	42.0	38	45.0

### Material

Stainless steel (AISI 316)

## 593 – High pressure hose



#								
	size DN	inch mm	inch mm	psi MPa	psi MPa	inch mm	lbs/ft kg/m	
593-12	-12	3/4	1.12	3,000	12,000	7.00	0.70	LV
	20	19.0	28.5	20.7	82.8	178.0	0.47	
593-16	-16	1	1.45	3,250	13,000	8.00	1.02	LV
	25	25.4	36.8	22.4	89.6	203.0	0.69	

### Construction

Core tube:	Polyester
Pressure reinforcement:	High strength wire
Cover:	Polyurethane, black (non perforated)

### Applications

Low volumetric expansion hose. Used for subsea hydraulic controls and BOP systems.

### Temperature range

-40°C up to +100°C, max. 70°C for water or methanol based fluids.  
-40°F up to +212°F, max. 158°F for water or methanol based fluids.  
Consult Parker for more detailed information.

## 106LV – JIC female swivel fitting

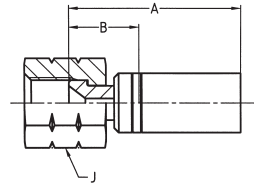

#	⊙		⚡	A	B	⬡ H	⬡ J	↻
	size DN	inch mm						
106LV-12-12C	-12	3/4	1 1/16 - 12UNF	4.12	1.81	1.13	1.25	5,000
	20	19.0		105.0	46.0	29	32	34.5
106LV-16-16C	1	25.4	1 5/16 - 12UNF	4.77	1.72	1.38	1.50	5,000
	25			121.0	44.0	35	38	34.5

### Material

Stainless steel (AISI 316), other materials on request.

593

---

**Chapter D****High pressure hydraulic control and testing**

<b>Textile reinforced hoses and related fittings .....</b>	<b>D-2</b>
<b>2020N</b> – Small bore hose .....	D-2
<b>520N</b> – Standard hydraulic hose .....	D-4
<b>HP</b> – High pressure hose .....	D-7
<b>Wire reinforced hoses and related fittings.....</b>	<b>D-10</b>
<b>2380N</b> – <b>polyflex</b> <sup>®</sup> hose .....	D-10
<b>2440N</b> – <b>polyflex</b> <sup>®</sup> hose .....	D-13

## 2020N – Small bore hose



#								
	size DN	inch mm	inch mm	psi MPa	psi MPa	inch mm	lbs/ft kg/m	
2020N-02V30	-02	1/8	0.24	5,800	23,200	1.18	0.05	RX
	3	3.2	6.1	40.0	160.0	30.0	0.07	

### Construction

**Core tube:** Polyamide  
**Pressure reinforcement:** One braided layer of high tensile aramid fibre  
**Cover:** Polyamide, black

### Applications

Small diameter, extremely flexible hose. Replaces steel tubing in instrumentation, diagnostic mini-hydraulic systems, and testing applications.

### Temperature range

-40°C up to +100°C, max. 70°C for water or methanol based fluids.  
 -40°F up to +212°F, max. 158°F for water or methanol based fluids.  
 Consult Parker for more detailed information.

**201RX – NPT male - 60° cone**

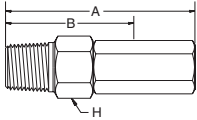

#	⊙		▄▄▄▄▄▄	A	B	⬡	⊙
	size DN	inch mm		inch mm	inch mm	inch mm	psi MPa
201RX-2-2C	-02 3	1/8 3.2	1/8 - 27NPTF	1.54 39.1	1.10 27.9	0.44 11	9,280 64.0

**Material**  
 Stainless steel (AISI 316), other materials on request.

**206RX – JIC female swivel fitting**

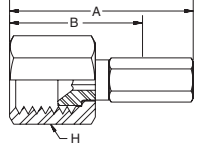

#	⊙		▄▄▄▄▄▄	A	B	⬡	⊙
	size DN	inch mm		inch mm	inch mm	inch mm	psi MPa
206RX-4-2C	-02 3	1/8 3.2	7/16 - 20UNF	1.56 36.9	1.10 27.9	0.56 14	9,280 64.0

**Material**  
 Stainless steel (AISI 316), other materials on request.

**Tube stub fitting**

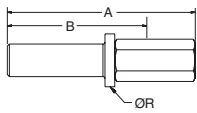







#	⊙		▄▄▄▄▄▄	A	B	ØR	⊙
	size DN	inch mm		inch mm	inch mm	inch mm	psi MPa
2TURX-4-2C	-02 3	1/8 3.2	1/4" tube	1.65 41.9	1.20 30.5	0.38 10.0	9,280 64.0

**Material**  
 Stainless steel (AISI 316), other materials on request.

## 520N – Standard hydraulic hose



520N

#														
	size DN	inch mm	inch mm	psi MPa	psi MPa	inch mm	lbs/ft kg/m							
520N-3	-03	3/16	0.35	5,000	20,000	1.50	0.036			55				
	5	4.8	8.9	34.5	138.0	38.0	0.07							
520N-4	-04	1/4	2.47	5,000	20,000	11.00	1.360			55				
	6	6.4	62.7	34.5	138.0	51.0	0.10							
520N-5	-05	5/16	0.38	4,500	18,000	1.50	0.043			55				
	8	7.9	9.7	31.0	124.0	64.0	0.12							
520N-6	-06	3/8	0.38	4,000	16,000	1.50	0.043			55				
	10	9.5	9.7	27.5	110.0	64.0	0.12							
520N-8	-08	1/2	0.38	3,500	14,000	1.50	0.043			55				
	12	12.7	9.7	24.0	96.0	102.0	0.20							

### Construction

**Core tube:** Polyamide  
**Pressure reinforcement:** One braided layer of high tensile aramid fibres  
**Cover:** Polyurethane, black, pinpricked

### Applications

Medium pressure hydraulic, pneumatic and lubricating oils including medium pressure tools, rigging jacks, test apparatus, oilfield pressure control devices and offshore oil applications.

### Temperature range

-40°C up to +100°C, max. 70°C for water or methanol based fluids.  
 -40°F up to +212°F, max. 158°F for water or methanol based fluids.  
 Consult Parker for more detailed information.

### Remarks

For non pinpricked alternative use 528N hose (orange cover). Same dimensions, pressures and fittings.

**10155 – NPT male - 60° cone**

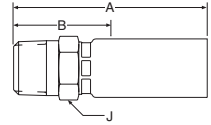

#	⊙		📐	A	B	⬡ J	↻
	size DN	inch mm					
10155-4-3C	-04	1/4	1/4 - 18NPTF	2.16	1.18	0.67	5,000
	6	6.4		55.0	30.0	17	34.5
10155-4-4C	-04	1/4	1/4 - 18NPTF	2.44	1.18	0.67	5,000
	6	6.4		62.0	30.0	17	34.5
10155-6-6C	-06	3/8	3/8 - 18NPTF	2.76	1.30	0.75	4,000
	10	9.5		70.0	33.0	19	27.5
10155-8-8C	-08	1/2	1/2 - 14NPTF	3.03	1.42	1.06	3,500
	12	12.7		77.0	36.0	27	24.0

520N

**Material**

Stainless steel (AISI 316), other materials on request.

**10655 – JIC female swivel fitting**

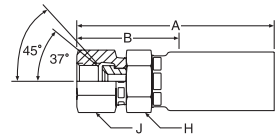

#	⊙		📐	A	B	⬡ H	⬡ J	↻
	size DN	inch mm						
10655-4-3C	-03	3/16	7/16 - 20UNF	2.17	1.18	0.63	0.67	5,000
	5	4.8		55.0	30.0	16	17	34.5
10655-4-4C	-04	1/4	7/16 - 20UNF	2.56	1.30	0.67	0.67	5,000
	6	6.4		65.0	33.0	17	17	34.5
10655-6-6C	-06	3/8	9/16 - 18UNF	2.72	1.30	0.75	0.75	4,000
	10	9.5		69.0	33.0	19	19	27.5
10655-8-8C	-08	1/2	3/4 - 16UNF	3.11	1.54	0.87	0.87	3,500
	12	12.7		79.0	38.0	22	22	24.0

**Material**

Stainless steel (AISI 316), other materials on request.

## 19255 – BSP female swivel fitting

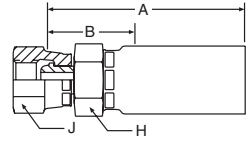

#	⊙		~~~~~	A	B	H	J	↻
	size DN	inch mm						
19255-4-3C	-03	3/16	G 1/4	2.09	1.10	0.67	0.75	5,000
	5	4.8		53.0	28.0	17	19	34.5
19255-4-4C	-04	1/4	G 1/4	2.28	1.02	0.67	0.75	5,000
	6	6.4		58.0	26.0	17	19	34.5
19255-6-6C	-06	3/8	G 3/8	2.52	1.06	0.75	0.87	4,000
	10	9.5		64.0	27.0	19	22	27.5
19255-8-8C	-08	1/2	G 5/8	2.91	1.22	0.94	1.06	3,500
	12	12.7		74.0	31.0	24	27	24.0

### Material

Stainless steel (AISI 316), other materials on request.

## 1C955 – Metric swivel with O-Ring Heavy series

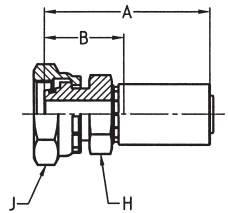

#	⊙		~~~~~	A	B	H	J	↻
	size DN	inch mm						
1C955-10-4C	-04	1/4	M18x1.5	2.64	1.42	0.87	0.87	5,000
	6	6.4		67.0	36.0	19	22	34.5
1C955-12-6C	-06	3/8	M20x1.5	2.68	1.26	0.87	0.94	4,000
	10	9.5		68.0	32.0	19	24	27.5
1C955-16-8C	-08	1/2	M24x1.5	3.03	1.42	0.94	1.18	3,500
	12	12.7		77.0	36.0	24	30	24.0

### Material

Stainless steel (AISI 316), other materials on request.

## HP – High pressure hose



#	○		◎		⊙	✂	↷	⊞	⊞
	size DN	inch mm	inch mm	psi MPa	psi MPa	inch mm	lbs/ft kg/m		
HP-3	-03	3/16	0.52	10,000	40,000	1.50	0.09	HP	
	5	4.8	13.2	69.0	276.0	38.0	0.13		
HP-4	-04	1/4	0.60	10,000	40,000	2.50	0.11	HP	
	6	6.4	15.2	69.0	276.0	64.0	0.16		
HPX-6	-06	3/8	0.74	10,000	32,000	3.00	0.16	HP	
	10	9.5	18.8	69.0	221.0	76.0	0.24		
HP8-3	-03	3/16	0.52	10,000	40,000	1.50	0.09	HP	
	5	4.8	13.2	69.0	276.0	38.0	0.13		
HP8-4	-04	1/4	0.60	10,000	40,000	2.50	0.11	HP	
	6	6.4	15.2	69.0	276.0	64.0	0.16		
HP8X-6	-06	3/8	0.74	10,000	32,000	3.00	0.16	HP	
	10	9.5	18.8	69.0	221.0	76.0	0.24		
2022NO-04V12*	-04	1/4	0.58	10,000	40,000	3.94	0.10	NX	
	6	6.4	14.8	69.0	276.0	100.0	0.15		

2020N

### Construction

**Core tube:** Polyamide  
**Pressure reinforcement:** One braided layer of high tensile aramid fibre  
**Cover:** Polyamide, HP: blue; HP8: orange; 2022NO: blue

### Applications

High pressure hydraulic, pneumatic and lubricating oils including high pressure tools, rigging jacks, test apparatus, oilfield pressure control devices and offshore oil applications.  
 HP8 is a non-conductive version.

### Temperature range

-40°C up to +100°C, max. 70°C for water or methanol based fluids.  
 -40°F up to +212°F, max. 158°F for water or methanol based fluids.  
 Consult Parker for more detailed information.

### Remark

\*: The 2022NO-04V12 is an alternative to HP with long length capability.

## 101HP – NPT male - 60° cone

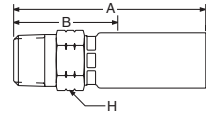

2020N

#	⊙		⌚	A	B	⬡	⌚
	size DN	inch mm					
101HP-2-3	-03	3/16	1/8 - 27NPTF	1.94	1.19	0.56	10,000
	5	4.8		49.0	30.0	14	69.0
101HP-2-4	-04	1/4	1/8 - 27NPTF	2.10	1.19	0.63	10,000
	6	6.4		53.0	30.0	16	69.0
101HP-4-3	-03	3/16	1/4 - 18NPTF	2.12	1.38	0.69	10,000
	5	4.8		54.0	35.0	18	69.0
101HP-4-4	-04	1/4	1/4 - 18NPTF	2.28	1.38	0.69	10,000
	6	6.4		58.0	35.0	18	69.0
101HP-4-6	-06	3/8	1/4 - 18NPTF	2.70	1.50	0.75	10,000
	10	9.5		69.0	38.0	19	69.0
101HP-6-3	-03	3/16	3/8 - 18NPTF	2.22	1.50	0.75	10,000
	5	4.8		56.0	38.0	19	69.0
101HP-6-4	-04	1/4	3/8 - 18NPTF	2.38	1.38	0.75	10,000
	6	6.4		60.0	35.0	19	69.0
101HP-6.6	-06	3/8	3/8 - 18NPTF	2.70	1.50	0.75	10,000
	10	9.5		69.0	38.0	19	69.0
101HP-8-6	-06	3/8	1/2 - 14NPTF	2.96	1.75	0.94	10,000
	10	9.5		75.0	44.0	24	69.0

### Material

Stainless steel (AISI 316), other materials on request.

**106HP – JIC female swivel fitting**

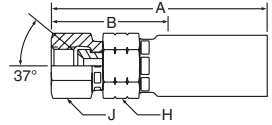

#	⊙		~~~~~	A	B	⬡	⬡	↻
	size DN	inch mm						
10655-6-06C	-03	3/16	7/16 - 20UNF	2.20	1.44	0.63	0.75	10,000
	5	4.8		56.0	36.6	16.0	19	69.0
10655-8-08C	-04	1/4	7/16 - 20UNF	2.49	1.56	0.63	0.94	10,000
	6	6.4		63.0	39.6	16.0	24	69.0
10658H-12-12C	-04	1/4	9/16 - 18UNF	2.59	1.69	0.75	1.31	10,000
	6	6.4		66.0	42.9	19.0	33	69.0
10658H-16-16C	-06	3/8	9/16 - 18UNF	2.91	1.63	0.75	1.63	10,000
	10	9.5		74.0	41.4	19.0	41	69.0

**Material**

Stainless steel (AISI 316), other materials on request.

**106NX – JIC female swivel fitting**

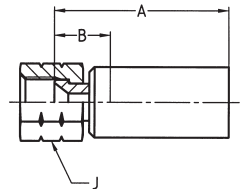

#	⊙		~~~~~	A	B	⬡	↻
	size DN	inch mm					
106NX-6-04-OF	-04	1/4	9/16 - 18UNF	2.17	0.91	0.87	10,000
	6	6.4		55.0	23.0	22	69.0

**Material**

Stainless steel (AISI 316), other materials on request.

## 2380N – polyflex® hose



2380N

#	⊙		⊙	↗		✂	↶	⊏	⊏
	size DN	inch mm	inch mm	psi * MPa	psi ** MPa	psi MPa	inch mm	lbs/ft kg/m	
2380N-04V00	-04	1/4	0.52	16,000	10,000	40,000	2.76	0.18	LX, 8X
	6	6.4	13.3	110.0	69.0	276.0	70.0	0.27	
2380N-04V02	-04	1/4	0.52	16,000	10,000	40,000	2.76	0.18	LX, 8X
	6	6.4	13.3	110.0	69.0	276.0	70.0	0.27	
2380N-04V04	-04	1/4	0.52	16,000	10,000	40,000	2.76	0.18	LX, 8X
	6	6.4	13.3	110.0	69.0	276.0	70.0	0.27	
2380N-04V71	-04	1/4	0.52	16,000	10,000	40,000	2.76	0.18	LX, 8X
	6	6.4	13.3	110.0	69.0	276.0	70.0	0.27	
2380N-05V71	-05	5/16	0.63	13,600	8,500	34,000	3.50	0.20	LX, 8X
	8	7.9	16.0	93.8	58.6	234.5	89.0	0.30	
2380N-06V10	-06	3/8	0.72	13,300	8,340	33,400	7.10	0.22	8X
	10	9.5	18.4	92.0	57.5	230.0	180.0	0.33	
2380N-08V10	-08	1/2	0.84	12,800	7,980	31,900	7.87	0.36	8X
	12	12.7	21.3	88.0	55.0	220.0	200.0	0.54	

\* Max. working pressure with 2.5:1 safety factor

\*\* Max. working pressure with 4:1 safety factor

### Construction

Core tube:	Polyamide
Pressure reinforcement:	High strength wire
Cover:	Polyurethane
	V10: black, V02: blue, V04: red, V71: black

### Applications

Small diameter, low volumetric expansion hose.  
Replaces high pressure rigid tubing where vibration and routing constraints are an issue.  
Used also for hydraulic controls, test systems with synthetic and phosphate ester fluids, V71 version typically used in methanol injection applications.

### Temperature range

At 4:1 safety factor:	-40°C up to +100°C, max. 70°C for water or methanol based fluids. -40°F up to +212°F, max. 158°F for water or methanol based fluids.
At 2.5:1 safety factor:	-40°C up to +60°C -40°F up to +140°F
	Consult Parker for more detailed information.

**1018X – NPT male**

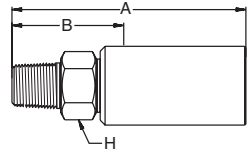

#	⊙		~~~~~	A	B	⬡	↗
	size DN	inch mm					
1018X-4-04C	-04	1/4	1/4" NPT	2.36	1.10	0.63	16,000
	6	6.4		60.0	28.0	16	110.0
1018X-6-05C	-05	5/16	3/8" NPT	2.95	1.34	0.75	13,600
	8	7.9		75.0	34.0	19	93.8
1018X-6-06C	-06	3/8	3/8" NPT	2.80	1.22	0.75	13,300
	10	9.5		71.0	31.0	19	93.0
1018X-8-08C	-08	1/2	1/2" NPT	3.11	1.42	0.87	12,800
	12	12.7		79.0	36.0	22	88.0

2380N

**Material**

Stainless steel (AISI 316), other materials on request.

**1068X – JIC female swivel fitting**

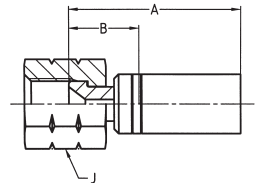

#	⊙		~~~~~	A	B	⬡	↗
	size DN	inch mm					
1068X-4-04C	-04	1/4	7/16 - 20UNF	2.24	0.98	0.63	16,000
	6	6.4		57.0	25.0	16	110.0
1068X-6-04C	-04	1/4	9/16 - 18UNF	2.36	1.10	0.67	16,000
	6	6.4		60.0	28.0	17	110.0
1068X-6-05C	-05	5/16	9/16 - 18UNF	2.72	1.10	0.75	13,600
	8	7.9		69.0	28.0	19	93.8
1068X-8-06C	-06	3/8	3/4 - 16UNF	2.32	0.75	0.94	13,300
	10	9.5		59.0	19.0	24	92.0
1068X-10-08C	-08	1/2	7/8 - 14UNF	2.48	0.75	1.06	12,800
	12	12.7		63.0	19.0	27	88.0

**Material**

Stainless steel (AISI 316), other materials on request.

## 1928X – BSP female swivel fitting

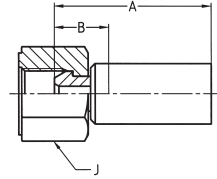

#	⊙		~~~~~	A	B	J	↗
	size DN	inch mm					
1928X-4-04C	-04	1/4	G 1/4	2.20	0.98	0.75	16,000
	6	6.4		56.0	25.0	19	110.0
1928X-6-06C	-06	3/8	G 3/8	2.32	0.75	0.87	13,300
	10	9.5		59.0	19.0	22	92.0
1928X-8-08C	-08	1/2	G 1/2	2.48	0.79	1.06	12,800
	12	12.7		63.0	20.0	27	88.0

### Material

Stainless steel (AISI 316), other materials on request.

## 6AYLX – 59° sealing cone UNF swivel nut

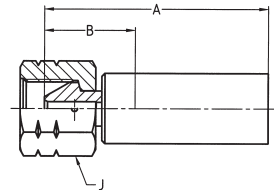

#	⊙		~~~~~	A	B	J	↗
	size DN	inch mm					
6AYLX-6-4C	-04	1/4	9/16 - 18UNF	2.68	1.38	0.67	16,000
	6	6.4		68.0	35.0	17	110.0
6AYLX-6-4C-SD*	-04	1/4	9/16 - 18UNF	2.56	1.30	0.75	16,000
	6	6.4		65.0	33.0	19	110.0
6AYLX-8-5C	-04	1/4	3/4 - 16UNF	2.95	1.26	0.98	13,600
	6	6.4		75.0	32.0	25	93.8

### Material

Stainless steel (AISI 316), other materials on request.

\*: Nipple made from high corrosion resistant steel, nut and shell stainless steel (AISI 316).

2440N – polyflex® hose



2440N

#	⊙		⊙	⊙	⊙	⊙	⊙	⊙
	size DN	inch mm	inch mm	psi* MPa	psi MPa	inch mm	lbs/ft kg/m	
2440N-04V37	-04	1/4	0.52	23,800	50,800	6.10	0.21	LX
	6	6.4	13.2	164.0	350.0	155.0	0.31	
2440N-04V91	-04	1/4	0.52	23,800	50,800	6.10	0.21	LX
	6	6.4	13.2	164.0	350.0	155.0	0.31	
2440N-06V37	-06	3/8	0.77	20,300	50,800	7.50	0.50	LX
	10	9.5	19.6	140.0	350.0	190.0	0.74	
2440N-06V91	-06	3/8	0.77	20,300	50,800	7.50	0.50	LX
	10	9.5	19.6	140.0	350.0	190.0	0.74	
2440N-08V37	-08	1/2	0.90	20,300	47,100	7.90	0.63	LX
	12	12.7	22.8	140.0	325.0	200.0	0.94	
2440N-08V91	-08	1/2	0.90	20,300	47,100	7.90	0.63	LX
	12	12.7	22.8	140.0	325.0	200.0	0.94	
2440N-12V37	-12	3/4	1.20	14,900	36,300	9.80	0.98	LX
	20	19.0	30.4	103.0	250.0	250.0	1.46	
2440N-12V91	-12	3/4	1.20	14,900	36,300	9.80	0.98	LX
	20	19.0	30.4	103.0	250.0	250.0	1.46	
2440N-16V37	-16	1	1.47	13,100	32,600	11.80	1.34	LX
	25	25.4	37.4	90.0	225.0	300.0	2.00	
2440N-16V91	-16	1	1.47	13,100	32,600	11.80	1.34	LX
	25	25.4	37.4	90.0	225.0	300.0	2.00	

\* Max. working pressure with 2.5:1 safety factor

**Construction**

**Core tube:** Polyamide. V91: methanol washed PA11  
**Pressure reinforcement:** High strength wire  
**Cover:** V37: PA, grey; V91: PA12, black

**Applications**

High pressure, low volumetric expansion hose.  
 Flexible, chemical resistance, and lightweight alternative to steel pipe and rubber hose for applications such as chemical injection, gas transfer, wirelogging services and pressure testing.  
 V91 version typically used in methanol injection applications.

**Temperature range**

-40°C up to +100°C, max. 70°C for water or methanol based fluids.  
 -40°F up to +212°F, max. 158°F for water or methanol based fluids.  
 Consult Parker for more detailed information.

## 106LX/606LX – JIC female swivel fitting

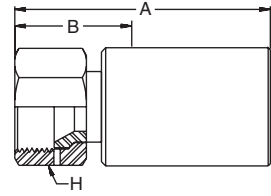

2440N

#	⊙		⌚	A	B	⬡ H	⌚
	size DN	inch mm					
106LX-6-04C	-04	1/4	9/16 - 18UNF	2.17	0.91	0.75	12,700
	6	6.4		55.0	23.0	19	87.5
106LX-6-06C	-06	3/8	9/16 - 18UNF	2.32	0.71	0.87	12,700
	10	9.5		59.0	18.0	22	87.5
106LX-8-06C	-06	3/8	3/4 - 16UNF	2.32	0.75	0.94	12,700
	10	9.5		59.0	19.0	24	87.5
106LX-8-08C	-08	1/2	3/4 - 16UNF	2.52	0.83	1.06	11,700
	12	12.7		64.0	21.0	27	81.0
106LX-10-08C	-08	1/2	1 - 12UNF	3.35	1.61	0.94	11,700
	12	12.7		85.0	41	24	81.0
606LX-16-12C	-12	3/4	1 5/16 - 12UNF	4.29	1.69	1.50	9,100
	20	19.0		109.0	43.0	38	63.0
606LX-16-16C	-16	1	1 5/16 - 12UNF	3.78	1.65	1.50	8,100
	25	25.4		96.0	42.0	38	56.0

### Material

Nipple made from high strength steel.

**1C9LX/606LX – Metric swivel with O-ring  
 Heavy series**

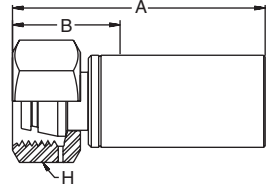

2440N

#	⊙		⌚	A	B	H	↗
	size DN	inch mm					
1C9LX-10-04C	-04	1/4	M18 x 1.5	2.76	1.30	0.87	12,700
	6	6.4		70.0	33.0	22	87.5
1C9LX-14-06C	-06	3/8	M22 x 1.5	2.99	1.18	1.18	12,700
	10	9.5		76.0	30.0	30	87.5
1C9LX-16-08C	-08	1/2	M24 x 1.5	3.46	1.34	1.26	11,700
	12	12.7		88.0	34.0	32	81.0
6C9LX-25-12C	-12	3/4	M36 x 2	4.25	1.57	1.81	9,100
	20	19.0		108.0	40.0	46	63.0
6C9LX-30-16C	-16	1	M42 x 2	5.47	1.77	2.17	8,100
	25	25.4		139.0	45.0	55	56.0

**Material**

Nipple made from high strength steel.

## 6AYLX – Type “M”

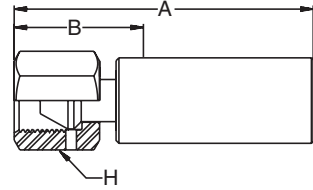

#	⊙		📐	A	B	⬡ H	📏
	size DN	inch mm					
6AYLX-6-4C	-04	1/4	9/16 - 18UNF	2.68	1.38	0.67	12,700
	6	6.4		68.0	35.0	17	87.5
6AYLX-6-4C-SD*	-04	1/4	9/16 - 18UNF	2.68	1.38	0.67	12,700
	6	6.4		68.0	35.0	17	87.5
6AYLX-8-6C	-06	3/8	3/4 - 16UNF	2.95	1.26	0.98	11,700
	10	9.5		75.0	32.0	25	81.0
6AYLX-11-8C	-08	1/2	1 - 12UNF	3.54	1.50	1.26	11,700
	12	12.7		90.0	38.0	32	81.0
6AYLX-11-8C-SD*	-08	1/2	1 - 12UNF	3.54	1.50	1.26	9,100
	12	12.7		90.0	38.0	32	63.0
6AYLX-16-12C	-12	3/4	1 5/16 - 12NPTF	4.13	1.54	1.50	9,100
	20	19.0		105.0	39.0	38	63.0
6AYLX-16-12C-SD*	-12	3/4	1 5/16 - 12NPTF	4.29	1.65	1.50	9,100
	20	19.0		109.0	42.0	38	63.0
6AYLX-16-16C	-16	1	1 5/16 - 12NPTF	5.47	2.05	1.50	8,100
	25	25.4		139.0	52.0	38	56.0
6AYLX-16-16C-SD*	-16	1	1 5/16 - 12NPTF	5.47	2.05	1.50	8,100
	25	25.4		139.0	52.0	38	56.0

### Material

Stainless steel (AISI 316), other materials on request.

\*: Nipple made from high corrosion resistant steel, nut and shell stainless steel (AISI 316).

**Chapter E**

**Large bore hoses for use in well services**

**2440N (V80) – polyflex® hose PHalcon with ColorGard ..... E-2**  
**2640N (V80) – polyflex® hose Black Eagle with ColorGard ..... E-5**

Large bore hoses for use in well services

**Wire reinforced hoses**

**2440N – polyflex® hose  
PHalcon + ColorGard®**



2440N

#	Ø		Ø	⌚	⌚	⌚	⌚	⌚
	size DN	inch mm	inch mm	psi MPa	psi MPa	inch mm	lbs/ft kg/m	
2440N-16V80*	-16	1	1.77	7,500	30,000	11.80	2.02	5X, LX
	25	25.4	45.0	51.7	207.0	300.0	3.00	
2440N-24V80*	-24	1 1/2	2.56	5,000	20,000	17.70	2.82	5X
	40	38.1	65.0	34.5	138.0	450.0	4.20	
2440N-32V80	-32	2	3.07	8,120	32,600	19.70	4.70	5X
	50	50.8	78.0	56.0	225.0	500.0	7.00	

\*: consult factory

**Construction**

**Core tube:** PA11  
**Pressure reinforcement:** High strength wire  
**Cover:** extra thick polyurethane cover with ColorGard® safety feature (red inner cover, black outer cover)

**Applications**

Used for high volume pumping in well service applications such as chemical injection and other onshore and subsea well stimulation operations.  
 Available in long continuous lengths.

**Temperature range**

-40°C up to +70°C,  
 -40°F up to +158°F

6015X – NPT male fitting

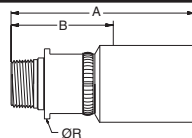

#	⊙		⌚	A	B	ØR	↗
	size DN	inch mm		inch mm	inch mm	inch mm	
6015X-32-24-TC	-24	1 1/2	2" - NPT	9.09	4.21	3.35	5,000
	40	38.1		231.0	107.0	85.0	
6015X-32-32-TC	-50	2	2" - NPT	10.51	4.09	3.27	5,000
	50	50.8		267.0	104.0	83.0	

Material

Stainless steel (AISI 316), other materials on request.

6AYLX – Type “M” swivel female fitting

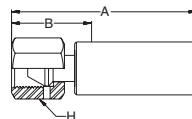

#	⊙		⌚	A	B	H	↗
	size DN	inch mm		inch mm	inch mm	inch mm	
6AYLX-16-16C-TC*	-16	1	1 5/16 - 12NPTF	4.76	2.17	1.97	7,500
	25	25.4		121.0	55.0	50	

\*: consult factory, also for materials

Material

Stainless steel (AISI 316), other materials on request.

6C9LX – Metric swivel fitting with O-ring

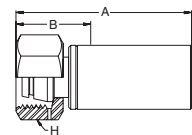

#	⊙		⌚	A	B	H	↗
	size DN	inch mm		inch mm	inch mm	inch mm	
6C9LX-30-16C-TC	-16	1	M42 x 2	4.76	2.17	1.97	7,500
	25	25.4		121.0	55.0	50	

Material

Stainless steel (AISI 316), other materials on request.

2440N

Large bore hoses for use in well services

**Wire reinforced hoses**

**6HE5X – Hammerlug union female**

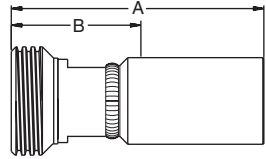

#	⊙		~~~~~	A	B	↻
	size DN	inch mm		inch mm	inch mm	
6HE5X-32-24-TC	-24	1 1/2	4 1/8"-3 ACME	10.71	5.79	5,000
	40	38.1		272.0	147.0	
6HE5X-32-32-TC	-50	2	4 1/8"-3 ACME	11.26	5.87	5,000
	50	50.8		286.0	149.0	

consult factory

**Material**

Stainless steel (AISI 316), other materials on request.

**6HN5X – Hammerlug union male**

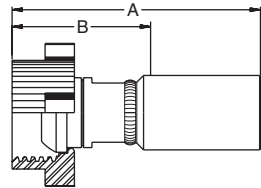

#	⊙		~~~~~	A	B	↻
	size DN	inch mm		inch mm	inch mm	
6HN5X-32-24-TC	-24	1 1/2	4 1/8"-3 ACME	9.13	4.25	5,000
	40	38.1		232.0	108.0	
6HN5X-32-32-TC	-50	2	4 1/8"-3 ACME	9.49	4.13	5,000
	50	50.8		241.0	105.0	

consult factory

**Material**

Stainless steel (AISI 316), other materials on request.

2440N

**2640N – polyflex® hose**  
**Black Eagle family + ColorGard®**



#	Ø		Ø	↗	↘	↘	⊥	⊥
	size DN	inch mm	inch mm	psi MPa	psi MPa	inch mm	lbs/ft kg/m	
2640N-16V80*	-16	1	1.57	15,000	43,500	15.80	1.95	5X
	25	25.4	40.0	103.5	300.0	400.0	2.90	
2640N-24V80	-24	1 1/2	2.76	10,000	33,400	19.70	4.84	5X
	40	38.1	70.0	69.0	230.0	500.0	7.20	
2640N-32V80	-32	2	3.31	10,000	25,000	31.50	6.18	5X
	50	50.8	84.0	69.0	172.5	800.0	9.20	

2640N

\*: consult factory

**Construction**

**Core tube:** PA11  
**Pressure reinforcement:** High strength wire  
**Cover:** extra thick polyurethane cover with ColorGard® safety feature (red inner cover, black outer cover)

**Applications**

Flexible, lightweight, chemical resistant alternative to steel or flexible pipe.  
 Used for high volume pumping in well service applications such as cementing chemical injection and other onshore and subsea well stimulation operations.  
 Available in long continuous lengths.

**Temperature range**

-40°C up to +70°C,  
 -40°F up to +158°F

Large bore hoses for use in well services

**Wire reinforced hoses**

**6015X – NPT Male fitting**

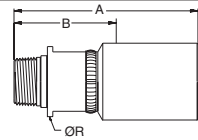

#	⊙		~~~~~	A	B	ØR	↗
	size DN	inch mm					
6015X-32-24-TC	-24	1 1/2	2" - NPT	9.09	4.21	3.35	10,000
	40	38.1		231.0	107.0	85.0	69.0
6015X-32-32-TC	-50	2	2" - NPT	10.51	4.09	3.27	10,000
	50	50.8		267.0	104.0	83.0	69.0

**Material**

Stainless steel (AISI 316), other materials on request.

**6AY5X – Type “M” swivel female fitting**

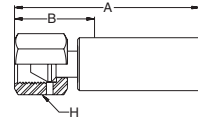

#	⊙		~~~~~	A	B	H	↗
	size DN	inch mm					
6AY5X-16-16C-TC*	-16	1	1 5/16 - 12NPTF	4.76	2.17	1.97	15,000
	25	25.4		121.0	55.0	50	103.5

\*: consult factory

**Material**

Stainless steel (AISI 316), other materials on request.

**6C95X – Metric swivel fitting with O-ring**

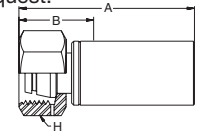

#	⊙		~~~~~	A	B	H	↗
	size DN	inch mm					
6C95X-30-16C-TC*	-16	1	M42 x 2	4.76	2.17	1.97	15,000
	25	25.4		121.0	55.0	50	103.5

\*: consult factory

**Material**

Stainless steel (AISI 316), other materials on request.

2640N

### 6HELX/6HE5X – Hammerlug union female

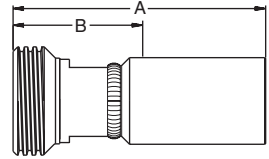

#				A	B	
	size DN	inch mm				
6HE5X-32-24-TC	-24	1 1/2	4 1/8"-3 ACME	10.71	5.79	10,000
	40	38.1		272.0	147.0	69.0
6HE5X-32-32-TC	-50	2	4 1/8"-3 ACME	11.26	5.87	10,000
	50	50.8		286.0	149.0	69.0

consult factory

#### Material

Stainless steel (AISI 316), other materials on request.

2640N

### 6HN5X – Hammerlug union male

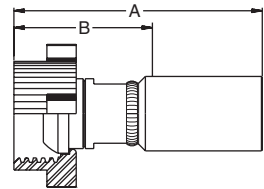

#				A	B	
	size DN	inch mm				
6HN5X-32-24-TC	-24	1 1/2	4 1/8"-3 ACME	9.13	4.25	10,000
	40	38.1		232.0	108.0	69.0
6HN5X-32-32-TC	-50	2	4 1/8"-3 ACME	9.49	4.13	10,000
	50	50.8		241.0	105.0	69.0

consult factory

#### Material

Stainless steel (AISI 316), other materials on request.



**Chapter F**

**Hose umbilicals**

Hose umbilicals.....F-2

**Hose umbilicals**

## Hose umbilicals

### Construction, applications, and manufacturing locations

Hose umbilicals



Parflex aramid reinforced hose (10,000 psi hose and lower) can be combined with **polyflex**® wire spiral reinforced hose (10,000 psi and above) in custom engineered umbilicals, also referred to as hose bundles. Our technical staff will help design a product to meet your specifications and routing requirements. Strength members, tubing, electrical cables, pneumatic lines, and more can be combined with hose, inside of a protective jacket per your custom specifications.

Typical applications include offshore and land-based exploration and drilling operations, hydraulic tool supply lines, and many others.

**polyflex**® unique manufacturing process can produce very long lengths of steel reinforced thermoplastic hose with very low volumetric expansion characteristics. High pressure, long lengths, light weight and fast response times are features that account for the success of **polyflex**® hose umbilicals.

Contact the division or visit our website with your ideas and requirements:

Internet: <http://www.parker.com>

E-mail: [polyflex@parker.com](mailto:polyflex@parker.com)

Parker has three manufacturing locations for hose umbilicals:

#### Hüttenfeld, Germany

General applications, maximum length 2000m

#### Ravenna, Ohio USA

General application, specialises in BOP umbilicals

#### Parker Cabett, Freeport Texas

Specialises in long length steel tube umbilicals. Handling capacity up to 1000 tonnes. Also offers electro/hydraulic umbilicals, end terminations, and installation service.

**Chapter G**

**High pressure adaptors, valves and NPT**

**Type M**

YAYA.....	G-5
YAY6.....	G-6
Plugs, caps and torpedos.....	G-7
YAY5.....	G-9
YA02.....	G-10
YA01.....	G-11

**20,000 PSI – Medium pressure**

5YY5.....	G-13
5YY6.....	G-14
6YY5.....	G-15
5Y01.....	G-16
025Y.....	G-18
5Y5Y.....	G-20
5Y6Y.....	G-22
5Y02.....	G-23
Y5Y5.....	G-25
Y5Y6.....	G-26
Y501.....	G-27
L5Y.....	G-29
T5Y.....	G-29
X5Y.....	G-30
Y2N.....	G-30
Y2C.....	G-30
Plugs.....	G-31
Nipples.....	G-31

**Table of contents**

Adapters

**30,000/60,000 psi – High pressure**

6YY6 .....	G-33
6Y01 .....	G-34
02Y6 .....	G-35
Y6Y6 .....	G-36
Y601 .....	G-37
6Y6Y .....	G-38
6Y02 .....	G-39
L6Y .....	G-40
T6Y .....	G-40
X6Y .....	G-41
Y4N .....	G-41
Y4C .....	G-41
HBPHM .....	G-42
Nipples .....	G-42
Locking Nut and Collar .....	G-42

**NPT**

K0202 – Couplers .....	G-44
KL02 – Elbows .....	G-44
KX02 – Crosses .....	G-45
KT02 – Tees .....	G-45
K0101 – Nipples .....	G-46
K0201 – Reducer bushings .....	G-46

**Valves –**

**Medium pressure (20,000 psi)**

SV5Y .....	G-48
AV5Y .....	G-49
TV25Y .....	G-50
TV15Y .....	G-51
CV5Y .....	G-52

**Valves –****High pressure (30,000 psi)**

SV6Y .....	G-53
AV6Y.....	G-54
TV26Y.....	G-55
TV16Y.....	G-56

**Valves –****High pressure (60,000 psi)**

SV6Y .....	G-57
AV6Y.....	G-58
TV26Y.....	G-59
TV16Y.....	G-60
CV6Y .....	G-61

## Type "M" swivel hose fitting and adapters

### Sizes

Determined by hose type.

9/16" - 18 thd

3/4" - 16 thd

7/8" - 14 thd

1" - 12 thd

1 5/16" - 12 thd

### Construction

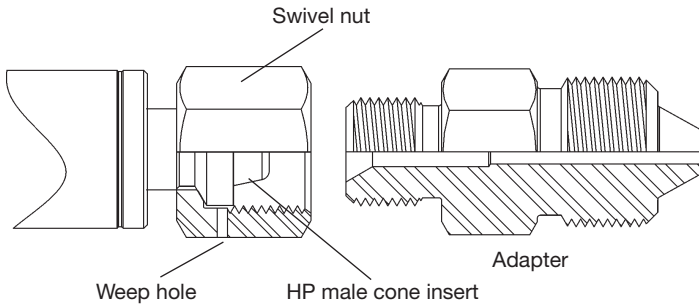

The Type "M" Swivel End Fitting is a swivel nut fitting with a 58° male cone nipple.





***Each Type "M" Swivel End Fitting is rated for the full working pressure of the hose.***

### Advantages

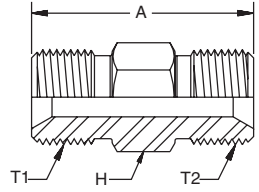
- Rated for the full working pressure of hose.
- Provides a swivel for quick and easy connection.
- Internal threads and seal are protected from external damage.
- Non rotating seal reduces galling and minimizes tightening torque.
- Can be adapted to almost any connection required.

**YAYA**  
Type "M" male x Type "M" male



#	 T1	 T2	A		 H	
			inch mm	inch mm		
YAYA-6-6C	9/16" - 18 UNF	9/16" - 18 UNF	1.38 35.1	0.63 16.0	60,000 413.7	
YAYA-8-6C	3/4" - 16 UNF	9/16" - 18 UNF	1.63 41.4	0.75 19.1	30,000 413.7	
YAYA-8-8C	3/4" - 16 UNF	3/4" - 16 UNF	1.75 44.5	0.75 19.1	30,000 206.8	
YAYA-10-6C	7/8" - 14 UNF	9/16" - 18 UNF	1.88 47.8	1.00 25.4	60,000 413.7	
YAYA-10-10C	7/8" - 14 UNF	7/8" - 14 UNF	2.00 50.8	1.00 25.4	60,000 413.7	
YAYA-11-8C	1" - 12 UNF	3/4" - 16 UNF	1.88 47.8	1.00 25.4	30,000 206.8	
YAYA-11-11C	1" - 12 UNF	1" - 12 UNF	1.88 47.8	1.00 25.4	30,000 206.8	
YAYA-16-11C	1-5/16" - 12 UNF	1" - 12 UNF	2.13 54.1	1.38 35.1	20,000 137.9	
YAYA-16-16C	1-5/16" - 12 UNF	1-5/16" - 12 UNF	2.13 54.1	1.38 35.1	20,000 137.9	

Adapters



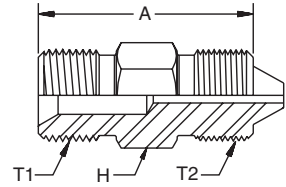

Adapters

**YAY6**

**Type "M" male x High pressure**





Adapters

#	 T1	 T2			A	 H	
			size DN	inch mm			
YAY6-6-4C	9/16" - 18 UNF	9/16" - 18 UNF	-04 6	1/4 6.4	1.53 38.7	0.63 16.0	60,000 413.7
YAY6-6-6C	9/16" - 18 UNF	3/4" - 16 UNF	-06 10	3/8 9.5	1.75 44.5	0.75 19.1	60,000 413.7
YAY6-6-9C	9/16" - 18 UNF	1-1/8" - 12 UNF	-05 8	5/16 7.9	2.00 50.8	1.13 28.7	60,000 413.7
YAY6-8-6C	3/4" - 16 UNF	3/4" - 16 UNF	-06 10	3/8 9.5	2.00 50.8	0.75 19.1	30,000 206.8
YAY6-8-9C	3/4" - 16 UNF	1-1/8" - 12 UNF	-05 8	5/16 7.9	2.25 57.1	1.13 28.7	30,000 206.8
YAY6-10-6C	7/8" - 14 UNF	3/4" - 16 UNF	-06 10	3/8 9.5	2.25 57.1	1.00 25.4	60,000 413.7
YAY6-10-9C	7/8" - 14 UNF	1-1/8" - 12 UNF	-05 8	5/16 7.9	2.38 60.5	1.13 28.7	60,000 413.7
YAY6-11-9C	1" - 12 UNF	1-1/8" - 12 UNF	-05 8	5/16 7.9	2.25 57.1	1.13 28.7	30,000 206.8

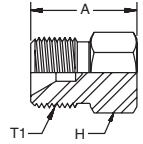

**Plugs**

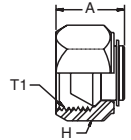

#	 T1	A			
		inch mm	inch mm		
YA6C-PLUG	9/16" - 18	2.07 52.6	0.75 19.1	60,000 413.7	
YA8C-PLUG	3/4" - 16	2.13 54.1	1.00 25.4	30,000 206.8	
YA11C-PLUG	1" - 12	1.25 31.8	1.00 25.4	30,000 206.8	
YA16C-PLUG	1 5/16" - 12	2.63 66.8	1.38 35.1	20,000 137.9	

**Caps**





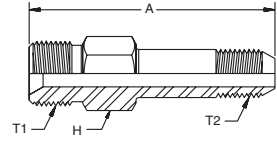

#	 T1	A			
		inch mm	inch mm		
YA6C-CAP	9/16" - 18	0.85 21.6	0.69 17.5	60,000 413.7	
YA8C-CAP	3/4" - 16	0.91 23.1	1.00 25.4	30,000 206.8	
YA11C-CAP	1" - 12	1.31 33.3	1.25 31.8	30,000 206.8	
YA16C-CAP	1 5/16" - 12	1.20 30.5	1.50 38.1	20,000 137.9	

Adapters

# Torpedos



#	 T1	 T2	A		 H	
			inch mm	inch mm		
YAY1-8-16C	3/4" - 16	1" - 14LH	3.56 90.4	1.13 28.7	20,000 137.9	
YAY2-8-16C	3/4" - 16	1" - 14LH	3.56 90.4	1.38 35.1	20,000 137.9	
YAY1-11-16C	1" - 12	1" - 14LH	3.56 90.4	1.13 28.7	20,000 137.9	
YAY2-11-16C	1" - 12	1" - 14LH	3.56 90.4	1.38 35.1	20,000 137.9	
YAY1-16-16C	1 5/16" - 12	1" - 14LH	3.70 94.0	1.38 35.1	20,000 137.9	
YAY2-16-16C	1 5/16" - 12	1" - 14LH	3.70 94.0	1.38 35.1	20,000 137.9	

Adapters

## YAY5 – Type "M" male x Medium pressure

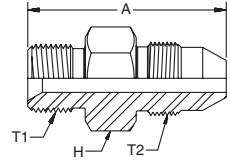



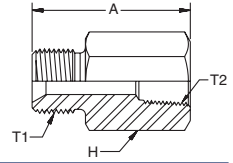

#	T1	T2	⊙		A	H	⊕
			size DN	inch mm			
YAY5-6-4C	9/16" - 18 UNF	7/16" - 20 UNF	-04 6	1/4 6.4	1.56 39.6	0.63 16.0	20,000 137.9
YAY5-6-6C	9/16" - 18 UNF	9/16" - 18 UNF	-06 10	3/8 9.5	1.63 41.4	0.63 16.0	20,000 137.9
YAY5-6-9C	9/16" - 18 UNF	13/16" - 16 UNF	-09	9/16	2.00 50.8	0.88 22.4	20,000 137.9
YAY5-6-12C	9/16" - 18 UNF	3/4" - 14 NPS	-12 20	3/4 19.0	2.32 58.9	1.13 28.7	20,000 137.9
YAY5-8-6C	3/4" - 16 UNF	9/16" - 18 UNF	-06 10	3/8 9.5	1.88 47.8	0.75 19.1	20,000 137.9
YAY5-8-9C	3/4" - 16 UNF	13/16" - 16 UNF	-09	9/16	2.20 55.9	0.88 22.4	20,000 137.9
YAY5-8-12C	3/4" - 16 UNF	3/4" - 14 NPS	-12 20	3/4 19.0	2.44 62.0	1.13 28.7	20,000 137.9
YAY5-11-6C	1" - 12 UNF	9/16" - 18 UNF	-06 10	3/8 9.5	2.00 50.4	1.00 25.4	20,000 137.9
YAY5-11-9C	1" - 12 UNF	13/16" - 16 UNF	-09	9/16	2.25 57.2	1.00 25.4	20,000 137.9
YAY5-11-12C	1" - 12 UNF	3/4" - 14 NPS	-12 20	3/4 19.0	2.44 62.0	1.13 28.7	20,000 137.9
YAY5-16-9C	1 5/16" - 12 UNF	9/16" - 18 UNF	-09	9/16	2.50 63.5	1.38 35.1	20,000 137.9
YAY5-16-12C	1 5/16" - 12 UNF	13/16" - 16 UNF	-12 20	3/4 19.0	2.70 68.6	1.38 35.1	20,000 137.9

**Adapters**

**YA02 – Type "M" male x NPT female**





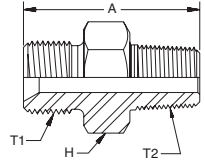

#	 T1	 T2	A		 H	
			inch	mm		
YA02-6-4C	9/16" - 18 UNF	1/4" - 18 UNF	1.50 38.1	0.75 19.1	15,000 103.4	
YA02-6-8C	9/16" - 18 UNF	1/2" - 14 UNF	2.00 50.8	1.25 31.8	15,000 103.4	
YA02-8-8C	3/4" - 16 UNF	1/2" - 14 UNF	2.00 50.8	1.25 31.8	15,000 103.4	
YA02-11-8C	1" - 12 UNF	1/2" - 14 UNF	2.50 63.5	1.00 25.4	15,000 103.4	

Adapters

## YA01 – Type “M” male x NPT male



#	 T1	 T2	A		 H	
			inch mm	inch mm		
YA01-6-2C	9/16" - 18 UNF	1/8" - 27 NPT	1.28 32.5	0.63 16.0	15,000 103.4	
YA01-6-4C	9/16" - 18 UNF	1/4" - 18 NPT	1.38 35.1	0.63 16.0	15,000 103.4	
YA01-6-6C	9/16" - 18 UNF	3/8" - 18 NPT	1.57 39.9	0.75 19.1	15,000 103.4	
YA01-6-8C	9/16" - 18 UNF	1/2" - 14 NPT	1.75 44.5	0.88 22.4	15,000 103.4	
YA01-8-4C	3/4" - 16 UNF	1/4" - 18 NPT	1.80 45.7	0.75 19.1	15,000 103.4	
YA01-8-6C	3/4" - 16 UNF	3/8" - 18 NPT	1.73 43.9	0.75 19.1	15,000 103.4	
YA01-8-8C	3/4" - 16 UNF	1/2" - 14 NPT	1.95 49.5	0.88 22.4	15,000 103.4	
YA01-8-12C	3/4" - 16 UNF	3/4" - 12 NPT	2.13 54.1	1.13 28.7	10,000 68.9	
YA01-8-16C	3/4" - 16 UNF	1" - 11 1/2 NPT	2.38 60.6	1.38 35.1	10,000 68.9	
YA01-11-6C	1" - 12 UNF	3/8" - 18 NPT	1.85 47.0	1.00 25.4	15,000 103.4	
YA01-11-8C	1" - 12 UNF	1/2" - 14 NPT	2.00 50.8	1.00 25.4	15,000 103.4	
YA01-11-12C	1" - 12 UNF	3/4" - 12 NPT	2.13 54.1	1.13 28.7	10,000 68.9	
YA01-11-16C	1" - 12 UNF	1" - 11 1/2 NPT	2.38 60.5	1.38 35.1	10,000 68.9	
YA01-16-8C	1 5/16" - 12 UNF	1/2" - 14 NPT	2.13 54.1	1.38 35.1	15,000 103.4	
YA01-16-12C	1 5/16" - 12 UNF	3/4" - 12 NPT	2.38 60.5	1.38 35.1	10,000 68.9	
YA01-16-16C	1 5/16" - 12 UNF	1" - 11 1/2 NPT	2.50 63.5	1.38 35.1	10,000 68.9	
YA01-16-20C	1 5/16" - 12 UNF	1 1/4" - 11 1/2 NPT	2.75 69.9	1.75 44.5	10,000 68.9	
YA01-16-24C	1 5/16" - 12 UNF	1 1/4" - 11 1/2 NPT	2.75 69.9	2.00 50.8	7,500 51.7	
YA01-16-32C	1 5/16" - 12 UNF	2" - 11 1/2 NPT	2.75 69.9	2.38 60.5	7,500 51.7	

## Medium pressure

### Sizes

1/4" O.D. x 0.109" I.D. • 7/16" - 20 male thread on gland nut  
3/8" O.D. x 0.19" I.D. • 9/16" - 18 male thread on gland nut  
9/16" O.D. x 0.31" I.D. • 13/16" - 16 male thread on gland nut  
3/4" O.D. x 0.44" I.D. • 3/4" - National Pipe Straight (NPT) male  
1" O.D. x 0.56" I.D. • 1 3/8" - 12 male thread on gland nut

Identification is by tubing O.D.

### Construction

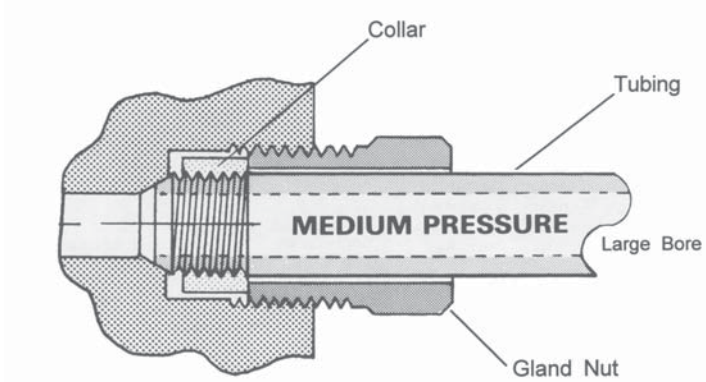



**Medium Pressure** is a 58/60° coned and threaded tubing design.  
*They have a maximum working pressure rating of 20,000 psi.*

### Advantages

- An industry standard for use at elevated pressures.
- Large orifice allows maximum flow of liquids and gases.
- Suitable for repetitive assembly and disassembly.

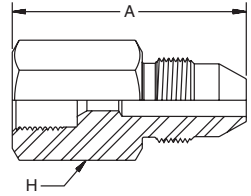
## 5YY5 – Female medium pressure to male medium pressure



#		A		H	
		inch mm	inch mm	psi MPa	
5YY5-4-6C	1/4" M.P. Female to 3/8" M.P. Male	1.75 44.5	0.75 19.1	20,000 137.9	
5YY5-4-9C	1/4" M.P. Female to 9/16" M.P. Male	1.87 47.5	0.87 22.1	20,000 137.9	
5YY5-4-12C	1/4" M.P. Female to 3/4" M.P. Male	2.00 50.8	1.12 28.4	20,000 137.9	
5YY5-4-16C	1/4" M.P. Female to 1" M.P. Male	3.00 76.2	1.00 25.4	20,000 137.9	
5YY5-6-4C	3/8" M.P. Female to 1/4" M.P. Male	1.75 44.5	0.75 19.1	20,000 137.9	
5YY5-6-9C	3/8" M.P. Female to 9/16" M.P. Male	1.87 47.5	0.87 22.1	20,000 137.9	
5YY5-6-12C	3/8" M.P. Female to 3/4" M.P. Male	2.00 50.8	1.12 28.4	20,000 137.9	
5YY5-6-16C	3/8" M.P. Female to 1" M.P. Male	3.12 79.2	1.00 25.4	20,000 137.9	
5YY5-9-4C	9/16" M.P. Female to 1/4" M.P. Male	2.12 53.8	1.00 25.4	20,000 137.9	
5YY5-9-6C	9/16" M.P. Female to 3/8" M.P. Male	2.12 53.8	1.00 25.4	20,000 137.9	
5YY5-9-12C	9/16" M.P. Female to 3/4" M.P. Male	2.50 63.5	1.12 28.4	20,000 137.9	
5YY5-9-16C	9/16" M.P. Female to 1" M.P. Male	3.37 85.6	1.00 25.4	20,000 137.9	
5YY5-12-4C	3/4" M.P. Female to 1/4" M.P. Male	1.25 31.8	1.37 34.8	20,000 137.9	
5YY5-12-6C	3/4" M.P. Female to 3/8" M.P. Male	2.37 60.2	1.37 34.8	20,000 137.9	
5YY5-12-9C	3/4" M.P. Female to 9/16" M.P. Male	2.87 72.9	1.37 34.8	20,000 137.9	
5YY5-12-16C	3/4" M.P. Female to 1" M.P. Male	3.75 95.3	1.37 34.8	20,000 137.9	
5YY5-16-4C	1" M.P. Female to 1/4" M.P. Male	2.75 69.9	1.75 44.5	20,000 137.9	
5YY5-16-6C	1" M.P. Female to 3/8" M.P. Male	2.87 72.9	1.75 44.5	20,000 137.9	
5YY5-16-9C	1" M.P. Female to 9/16" M.P. Male	3.00 76.2	1.75 44.5	20,000 137.9	
5YY5-16-12C	1" M.P. Female to 3/4" M.P. Male	3.25 82.6	1.75 44.5	20,000 137.9	

Adapters

**5YY6 – Female medium pressure to male high pressure**

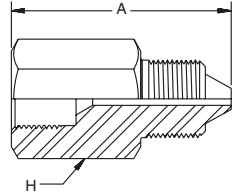

Adapters

#		A			
		inch mm	inch mm		
5YY6-4-4C	1/4" M.P. Female to 1/4" H.P. Male	1.37 34.8	0.75 19.1	20,000 137.9	
5YY6-4-6C	1/4" M.P. Female to 3/8" H.P. Male	1.75 44.5	0.75 19.1	20,000 137.9	
5YY6-4-9C	1/4" M.P. Female to 9/16" H.P. Male	2.12 53.8	1.12 28.4	20,000 137.9	
5YY6-6-4C	3/8" M.P. Female to 1/4" H.P. Male	1.75 44.5	0.75 19.1	20,000 137.9	
5YY6-6-6C	3/8" M.P. Female to 3/8" H.P. Male	1.75 44.5	0.75 19.1	20,000 137.9	
5YY6-6-9C	3/8" M.P. Female to 9/16" H.P. Male	2.12 53.8	1.12 28.4	20,000 137.9	
5YY6-9-4C	9/16" M.P. Female to 1/4" H.P. Male	1.87 47.5	1.00 25.4	20,000 137.9	
5YY6-9-6C	9/16" M.P. Female to 3/8" H.P. Male	2.12 53.8	1.00 25.4	20,000 137.9	
5YY6-9-9C	9/16" M.P. Female to 9/16" H.P. Male	2.12 53.8	1.12 28.4	20,000 137.9	
5YY6-12-4C	3/4" M.P. Female to 1/4" H.P. Male	2.50 63.5	1.37 34.8	20,000 137.9	
5YY6-12-6C	3/4" M.P. Female to 3/8" H.P. Male	2.37 60.2	1.37 34.8	20,000 137.9	
5YY6-12-9C	3/4" M.P. Female to 9/16" H.P. Male	2.62 66.5	1.37 34.8	20,000 137.9	
5YY6-16-4C	1" M.P. Female to 1/4" H.P. Male	2.62 66.5	1.75 44.5	20,000 137.9	
5YY6-16-6C	1" M.P. Female to 3/8" H.P. Male	2.87 72.9	1.75 44.5	20,000 137.9	
5YY6-16-9C	1" M.P. Female to 9/16" H.P. Male	3.12 79.2	1.75 44.5	20,000 137.9	

**6YY5 – Female high pressure to male medium pressure**

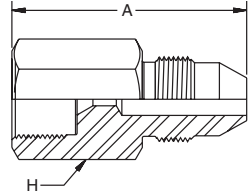

#		A			
		inch mm	inch mm	inch mm	psi MPa
6YY5-4-4C	1/4" H.P. Female to 1/4" M.P. Male	1.75 44.5	0.75 19.1	20,000 137.9	
6YY5-4-6C	1/4" H.P. Female to 3/8" M.P. Male	1.75 44.5	0.75 19.1	20,000 137.9	
6YY5-4-9C	1/4" H.P. Female to 9/16" M.P. Male	1.87 47.5	0.87 22.1	20,000 137.9	
6YY5-4-12C	1/4" H.P. Female to 3/4" M.P. Male	2.25 57.2	1.12 28.4	20,000 137.9	
6YY5-4-16C	1/4" H.P. Female to 1" M.P. Male	3.00 76.2	1.00 25.4	20,000 137.9	
6YY5-6-4C	3/8" H.P. Female to 1/4" M.P. Male	1.87 47.5	1.00 25.4	20,000 137.9	
6YY5-6-6C	3/8" H.P. Female to 3/8" M.P. Male	1.87 47.5	1.00 25.4	20,000 137.9	
6YY5-6-9C	3/8" H.P. Female to 9/16" M.P. Male	2.00 50.8	1.00 25.4	20,000 137.9	
6YY5-6-12C	3/8" H.P. Female to 3/4" M.P. Male	2.25 57.2	1.12 28.4	20,000 137.9	
6YY5-6-16C	3/8" H.P. Female to 1" M.P. Male	3.25 82.6	1.00 25.4	20,000 137.9	
6YY5-9-4C	9/16" H.P. Female to 1/4" M.P. Male	2.12 53.8	1.37 34.8	20,000 137.9	
6YY5-9-6C	9/16" H.P. Female to 3/8" M.P. Male	2.12 53.8	1.37 34.8	20,000 137.9	
6YY5-9-9C	9/16" H.P. Female to 9/16" M.P. Male	2.37 60.2	1.37 34.8	20,000 137.9	
6YY5-9-12C	9/16" H.P. Female to 3/4" M.P. Male	2.50 63.5	1.37 34.8	20,000 137.9	
6YY5-9-16C	9/16" H.P. Female to 1" M.P. Male	3.62 91.1	1.37 34.8	20,000 137.9	



Adapters

**Adapters**

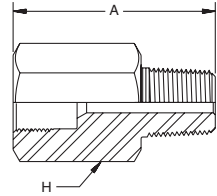
**5Y01 – Female medium pressure to NPT male**







Adapters

#		A			
		inch mm	inch mm		
5Y01-4-2C	1/4" M.P. Female to 1/8" NPT Male	1.43 36.3	0.75 19.1	15,000 139.7	
5Y01-4-4C	1/4" M.P. Female to 1/4" NPT Male	1.62 41.1	0.75 19.1	15,000 139.7	
5Y01-4-6C	1/4" M.P. Female to 3/8" NPT Male	1.62 41.1	0.75 19.1	15,000 139.7	
5Y01-4-8C	1/4" M.P. Female to 1/2" NPT Male	1.75 44.5	1.00 25.4	15,000 139.7	
5Y01-4-12C	1/4" M.P. Female to 3/4" NPT Male	1.87 47.5	1.37 34.8	10,000 103.4	
5Y01-4-16C	1/4" M.P. Female to 1" NPT Male	1.87 47.5	1.37 34.8	10,000 103.4	
5Y01-6-2C	3/8" M.P. Female to 1/8" NPT Male	1.43 36.3	0.75 19.1	15,000 139.7	
5Y01-6-4C	3/8" M.P. Female to 1/4" NPT Male	1.62 41.1	0.75 19.1	15,000 139.7	
5Y01-6-6C	3/8" M.P. Female to 3/8" NPT Male	1.62 41.1	0.75 19.1	15,000 139.7	
5Y01-6-8C	3/8" M.P. Female to 1/2" NPT Male	1.74 44.2	1.00 25.4	15,000 139.7	
5Y01-6-12C	3/8" M.P. Female to 3/4" NPT Male	1.87 47.5	1.37 34.8	10,000 103.4	
5Y01-6-16C	3/8" M.P. Female to 1" NPT Male	1.87 47.5	1.37 34.8	10,000 103.4	
5Y01-9-2C	9/16" M.P. Female to 1/4" NPT Male	1.87 47.5	1.00 25.4	15,000 139.7	
5Y01-9-4C	9/16" M.P. Female to 1/4" NPT Male	1.87 47.5	1.00 25.4	15,000 139.7	
5Y01-9-6C	9/16" M.P. Female to 3/8" NPT Male	1.87 47.5	1.00 25.4	15,000 139.7	
5Y01-9-8C	9/16" M.P. Female to 1/2" NPT Male	1.87 47.5	1.00 25.4	15,000 139.7	
5Y01-9-12C	9/16" M.P. Female to 3/4" NPT Male	1.87 47.5	1.37 34.8	10,000 103.4	
5Y01-9-16C	9/16" M.P. Female to 1" NPT Male	1.87 47.5	1.37 34.8	10,000 103.4	

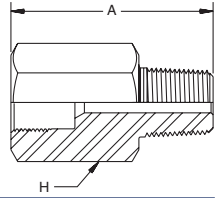
(continued)

**5Y01 – Female medium pressure to NPT male (continued)**





#		A			
		inch mm	inch mm	inch mm	psi MPa
5Y01-12-2C	3/4" M.P. Female to 1/8" NPT Male	2.50 63.5	1.37 34.8	15,000 139.7	
5Y01-12-4C	3/4" M.P. Female to 1/4" NPT Male	2.50 63.5	1.37 34.8	15,000 139.7	
5Y01-12-6C	3/4" M.P. Female to 3/8" NPT Male	2.50 63.5	1.37 34.8	15,000 139.7	
5Y01-12-8C	3/4" M.P. Female to 1/2" NPT Male	2.50 63.5	1.37 34.8	15,000 139.7	
5Y01-12-12C	3/4" M.P. Female to 3/4" NPT Male	2.50 63.5	1.37 34.8	15,000 139.7	
5Y01-12-16C	3/4" M.P. Female to 1" NPT Male	2.50 63.5	1.37 34.8	15,000 139.7	
5Y01-16-2C	1" M.P. Female to 1/8" NPT Male	2.50 63.5	1.37 34.8	15,000 139.7	
5Y01-16-4C	1" M.P. Female to 1/4" NPT Male	2.50 63.5	1.37 34.8	15,000 139.7	
5Y01-16-6C	1" M.P. Female to 3/8" NPT Male	2.50 63.5	1.37 34.8	15,000 139.7	
5Y01-16-8C	1" M.P. Female to 1/2" NPT Male	2.50 63.5	1.37 34.8	15,000 139.7	
5Y01-16-12C	1" M.P. Female to 3/4" NPT Male	2.50 63.5	1.37 34.8	15,000 139.7	
5Y01-16-16C	1" M.P. Female to 1" NPT Male	2.50 63.5	1.37 34.8	10,000 103.4	

Adapters

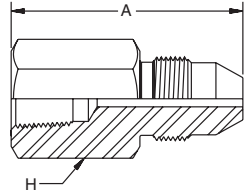
## 02Y5 – Female NPT to male medium pressure

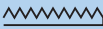



#		A			
		inch mm	inch mm	psi MPa	
02Y5-2-12C	1/8" NPT Female to 3/4" M.P. Male	2.00 50.8	1.12 28.4	15,000 103.4	
02Y5-2-16C	1/8" NPT Female to 1" M.P. Male	3.00 76.2	1.00 25.4	15,000 103.4	
02Y5-2-4C	1/8" NPT Female to 1/4" M.P. Male	1.75 44.5	0.75 19.1	15,000 103.4	
02Y5-2-6C	1/8" NPT Female to 3/8" M.P. Male	1.87 47.5	0.75 19.1	15,000 103.4	
02Y5-2-9C	1/8" NPT Female to 9/16" M.P. Male	1.87 47.5	0.87 22.1	15,000 103.4	
02Y5-4-4C	1/4" NPT Female to 1/4" M.P. Male	1.75 44.5	0.75 19.1	15,000 103.4	
02Y5-4-6C	1/4" NPT Female to 3/8" M.P. Male	1.87 47.5	0.75 19.1	15,000 103.4	
02Y5-4-9C	1/4" NPT Female to 9/16" M.P. Male	1.87 47.5	0.87 22.1	15,000 103.4	
02Y5-4-12C	1/4" NPT Female to 3/4" M.P. Male	2.00 50.8	1.12 28.4	15,000 103.4	
02Y5-4-16C	1/4" NPT Female to 1" M.P. Male	3.00 76.2	1.00 25.4	15,000 103.4	
02Y5-6-4C	3/8" NPT Female to 1/4" M.P. Male	2.00 50.8	1.00 25.4	15,000 103.4	
02Y5-6-6C	3/8" NPT Female to 3/8" M.P. Male	2.12 53.8	1.00 25.4	15,000 103.4	
02Y5-6-9C	3/8" NPT Female to 9/16" M.P. Male	2.25 57.2	1.00 25.4	15,000 103.4	
02Y5-6-12C	3/8" NPT Female to 3/4" M.P. Male	2.00 50.8	1.12 28.4	15,000 103.4	
02Y5-6-16C	3/8" NPT Female to 1" M.P. Male	3.00 76.2	1.00 25.4	15,000 103.4	
02Y5-8-4C	1/2" NPT Female to 1/4" M.P. Male	2.12 53.8	1.12 28.4	15,000 103.4	
02Y5-8-6C	1/2" NPT Female to 3/8" M.P. Male	1.25 31.8	1.12 28.4	15,000 103.4	
02Y5-8-8C	1/2" NPT Female to 9/16" M.P. Male	2.37 60.2	1.12 28.4	15,000 103.4	
02Y5-8-12C	1/2" NPT Female to 3/4" M.P. Male	2.50 63.5	1.12 28.4	15,000 103.4	
02Y5-8-16C	1/2" NPT Female to 1" M.P. Male	3.75 95.3	1.12 28.4	15,000 103.4	

(continued)

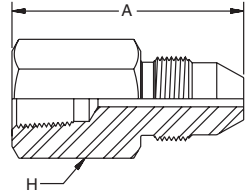
**02Y5 – Female NPT  
to male medium pressure (continued)**





#		A			
		inch mm	inch mm	psi MPa	
02Y5-12-4C	3/4" NPT Female to 1/4" M.P. Male	2.37 60.2	1.37 34.8	10,000 68.9	
02Y5-12-6C	3/4" NPT Female to 3/8" M.P. Male	2.50 63.5	1.37 34.8	10,000 68.9	
02Y5-12-9C	3/4" NPT Female to 9/16" M.P. Male	2.62 66.5	1.37 34.8	10,000 68.9	
02Y5-12-12C	3/4" NPT Female to 3/4" M.P. Male	2.75 69.9	1.50 38.1	10,000 68.9	
02Y5-12-16C	3/4" NPT Female to 1" M.P. Male	4.12 104.6	1.50 38.1	10,000 68.9	
02Y5-16-6C	1" NPT Female to 3/8" M.P. Male	2.87 72.9	1.87 47.5	10,000 68.9	
02Y5-16-9C	1" NPT Female to 9/16" M.P. Male	3.00 76.2	1.87 47.5	10,000 68.9	
02Y5-16-12C	1" NPT Female to 3/4" M.P. Male	3.00 76.2	1.87 47.5	10,000 68.9	
02Y5-16-16C	1" NPT Female to 1" M.P. Male	4.37 111.0	1.87 47.5	10,000 68.9	

Adapters

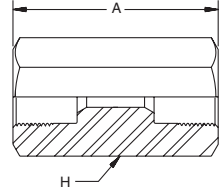
## 5Y5Y – Straight coupling



#		A			
		inch mm	inch mm	inch mm	psi MPa
5Y5Y-4-4C	1/4" Medium pressure female	1.62 41.1	0.75 19.1	20,000 137.9	
5Y5Y-6-6C	3/8" Medium pressure female	1.75 44.5	0.75 19.1	20,000 137.9	
5Y5Y-9-9C	9/16" Medium pressure female	2.12 53.8	1.00 25.4	20,000 137.9	
5Y5Y-12-12C	3/4" Medium pressure female	2.50 63.5	1.37 34.8	20,000 137.9	
5Y5Y-16-16C	1" Medium pressure female	3.50 88.9	1.75 44.5	20,000 137.9	

Adapters

### 5Y5Y – Reducer coupling

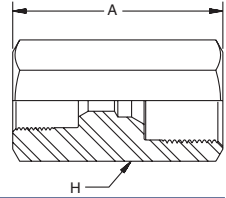

#		A		H		⌀	
		inch mm	inch mm	inch mm	psi MPa	inch mm	psi MPa
5Y5Y-4-6C	1/4" M.P. Female to 3/8" M.P. Female	1.75 44.5	0.75 19.1	20,000 137.9			
5Y5Y-4-9C	1/4" M.P. Female to 9/16" M.P. Female	2.12 53.8	1.00 25.4	20,000 137.9			
5Y5Y-4-12C	1/4" M.P. Female to 3/4" M.P. Female	2.50 63.5	1.37 34.8	20,000 137.9			
5Y5Y-4-16C	1/4" M.P. Female to 1" M.P. Female	3.50 88.9	1.75 44.5	20,000 137.9			
5Y5Y-6-9C	3/8" M.P. Female to 9/16" M.P. Female	2.12 53.8	1.00 25.4	20,000 137.9			
5Y5Y-6-12C	3/8" M.P. Female to 3/4" M.P. Female	2.50 63.5	1.37 34.8	20,000 137.9			
5Y5Y-6-16C	3/8" M.P. Female to 1" M.P. Female	3.50 88.9	1.75 44.5	20,000 137.9			
5Y5Y-9-12C	9/16" M.P. Female to 3/4" M.P. Female	2.50 63.5	1.37 34.8	20,000 137.9			
5Y5Y-9-16C	9/16" M.P. Female to 1" M.P. Female	3.50 88.9	1.75 44.5	20,000 137.9			
5Y5Y-12-16C	3/4" M.P. Female to 1" M.P. Female	3.50 88.9	1.75 44.5	20,000 137.9			



Adapters

**Adapters**

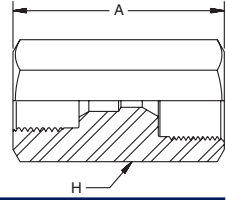

**5Y6Y – Female medium pressure to female high pressure coupling**

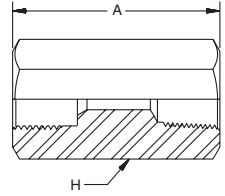

Adapters

#		A			
		inch mm	inch mm	inch mm	psi MPa
5Y6Y-4-4C	1/4" M.P. Female to 1/4" H.P. Female	1.62 41.1	0.75 19.1	20,000 137.9	
5Y6Y-4-6C	1/4" M.P. Female to 3/8" H.P. Female	1.87 47.5	1.00 25.4	20,000 137.9	
5Y6Y-4-9C	1/4" M.P. Female to 9/16" H.P. Female	2.37 60.2	1.37 34.8	20,000 137.9	
5Y6Y-6-4C	3/8" M.P. Female to 1/4" H.P. Female	1.75 44.5	0.75 19.1	20,000 137.9	
5Y6Y-6-6C	3/8" M.P. Female to 3/8" H.P. Female	1.87 47.5	1.00 25.4	20,000 137.9	
5Y6Y-6-9C	3/8" M.P. Female to 9/16" H.P. Female	2.37 60.2	1.37 34.8	20,000 137.9	
5Y6Y-9-4C	9/16" M.P. Female to 1/4" H.P. Female	2.12 53.8	1.00 25.4	20,000 137.9	
5Y6Y-9-6C	9/16" M.P. Female to 3/8" H.P. Female	2.12 53.8	1.00 25.4	20,000 137.9	
5Y6Y-9-9C	9/16" M.P. Female to 9/16" H.P. Female	2.37 60.2	1.37 34.8	20,000 137.9	
5Y6Y-12-4C	3/4" M.P. Female to 1/4" H.P. Female	2.50 63.5	1.37 34.8	20,000 137.9	
5Y6Y-12-6C	3/4" M.P. Female to 3/8" H.P. Female	2.50 63.5	1.37 34.8	20,000 137.9	
5Y6Y-12-9C	3/4" M.P. Female to 9/16" H.P. Female	2.50 63.5	1.37 34.8	20,000 137.9	
5Y6Y-16-4C	1" M.P. Female to 1/4" H.P. Female	3.50 88.9	1.37 34.8	20,000 137.9	
5Y6Y-16-6C	1" M.P. Female to 3/8" H.P. Female	3.50 88.9	1.37 34.8	20,000 137.9	
5Y6Y-16-9C	1" M.P. Female to 9/16" H.P. Female	3.50 88.9	1.37 34.8	20,000 137.9	

**5Y02 – Female medium pressure  
to NPT female coupling**

#		A			
		inch mm	inch mm	inch mm	psi MPa
5Y02-4-2C	1/4" M.P. Female to 1/8" NPT Female	1.62 41.1	0.75 19.1	15,000 103.4	
5Y02-4-4C	1/4" M.P. Female to 1/4" NPT Female	1.62 41.1	0.75 19.1	15,000 103.4	
5Y02-4-6C	1/4" M.P. Female to 3/8" NPT Female	2.00 50.8	1.00 25.4	15,000 103.4	
5Y02-4-8C	1/4" M.P. Female to 1/2" NPT Female	2.00 50.8	1.12 28.4	15,000 103.4	
5Y02-4-12C	1/4" M.P. Female to 3/4" NPT Female	2.37 60.2	1.37 34.8	10,000 68.9	
5Y02-4-16C	1/4" M.P. Female to 1" NPT Female	2.62 66.5	2.00 50.8	10,000 68.9	
5Y02-6-2C	3/8" M.P. Female to 1/8" NPT Female	1.75 44.5	0.75 19.1	15,000 103.4	
5Y02-6-4C	3/8" M.P. Female to 1/4" NPT Female	1.75 44.5	0.75 19.1	15,000 103.4	
5Y02-6-6C	3/8" M.P. Female to 3/8" NPT Female	2.12 53.8	1.00 25.4	15,000 103.4	
5Y02-6-8C	3/8" M.P. Female to 1/2" NPT Female	2.12 53.8	1.12 28.4	15,000 103.4	
5Y02-6-12C	3/8" M.P. Female to 3/4" NPT Female	2.37 60.2	1.37 34.8	10,000 68.9	
5Y02-6-16C	3/8" M.P. Female to 1" NPT Female	2.75 69.9	2.00 50.8	10,000 68.9	
5Y02-9-2C	9/16" M.P. Female to 1/8" NPT Female	2.12 53.8	1.00 25.4	15,000 103.4	
5Y02-9-4C	9/16" M.P. Female to 1/4" NPT Female	2.12 53.8	1.00 25.4	15,000 103.4	
5Y02-9-6C	9/16" M.P. Female to 3/8" NPT Female	2.12 53.8	1.00 25.4	15,000 103.4	
5Y02-9-8C	9/16" M.P. Female to 1/2" NPT Female	2.25 57.2	1.12 28.4	15,000 103.4	
5Y02-9-12C	9/16" M.P. Female to 3/4" NPT Female	2.50 63.5	1.37 34.8	10,000 68.9	
5Y02-9-16C	9/16" M.P. Female to 1" NPT Female	2.87 72.9	2.00 50.8	10,000 68.9	



(continued)

**Adapters**

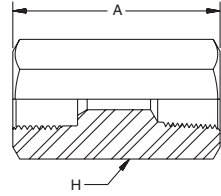
**5Y02 – Female medium pressure to NPT female coupling (continued)**

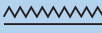

Adapters

#		A			
		inch mm	inch mm	inch mm	psi MPa
5Y02-12-2C	3/4" M.P. Female to 1/8" NPT Female	2.50 63.5	1.37 34.8	15,000 103.4	
5Y02-12-4C	3/4" M.P. Female to 1/4" NPT Female	2.50 63.5	1.37 34.8	15,000 103.4	
5Y02-12-6C	3/4" M.P. Female to 3/8" NPT Female	2.50 63.5	1.37 34.8	15,000 103.4	
5Y02-12-8C	3/4" M.P. Female to 1/2" NPT Female	2.50 63.5	1.37 34.8	15,000 103.4	
5Y02-12-12C	3/4" M.P. Female to 3/4" NPT Female	2.75 69.9	1.50 38.1	10,000 68.9	
5Y02-12-16C	3/4" M.P. Female to 1" NPT Female	3.00 76.2	1.87 47.5	10,000 68.9	
5Y02-16-2C	1" M.P. Female to 1/8" NPT Female	3.00 76.2	1.75 44.5	15,000 103.4	
5Y02-16-4C	1" M.P. Female to 1/4" NPT Female	3.00 76.2	1.75 44.5	15,000 103.4	
5Y02-16-6C	1" M.P. Female to 3/8" NPT Female	3.00 76.2	1.75 44.5	15,000 103.4	
5Y02-16-8C	1" M.P. Female to 1/2" NPT Female	3.00 76.2	1.75 44.5	15,000 103.4	
5Y02-16-12C	1" M.P. Female to 3/4" NPT Female	3.50 88.9	1.50 38.1	10,000 68.9	
5Y02-16-16C	1" M.P. Female to 1" NPT Female	3.75 95.2	1.87 47.5	10,000 68.9	

**Y5Y5 – Male medium pressure to male medium pressure**

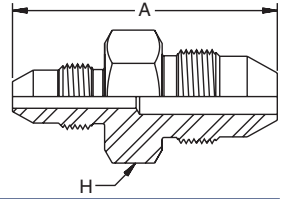

#				
		inch mm	inch mm	psi MPa
Y5Y5-4-4C	1/4" M.P. Male to 1/4" M.P. Male	2.00 50.8	0.62 15.7	20,000 137.9
Y5Y5-4-6C	1/4" M.P. Male to 3/8" M.P. Male	2.12 53.8	0.75 19.1	20,000 137.9
Y5Y5-4-12C	1/4" M.P. Male to 3/4" M.P. Male	2.50 50.8	1.12 28.4	20,000 137.9
Y5Y5-4-16C	1/4" M.P. Male to 1" M.P. Male	3.62 91.9	1.00 25.4	20,000 137.9
Y5Y5-6-6C	3/8" M.P. Male to 3/8" M.P. Male	2.25 57.2	0.75 19.1	20,000 137.9
Y5Y5-6-9C	3/8" M.P. Male to 9/16" M.P. Male	2.50 63.5	0.87 22.1	20,000 137.9
Y5Y5-6-12C	3/8" M.P. Male to 3/4" M.P. Male	2.62 66.5	1.12 28.4	20,000 137.9
Y5Y5-6-16C	3/8" M.P. Male to 1" M.P. Male	3.75 95.3	1.00 25.4	20,000 137.9
Y5Y5-9-9C	9/16" M.P. Male to 9/16" M.P. Male	2.50 63.5	1.00 25.4	20,000 137.9
Y5Y5-9-12C	9/16" M.P. Male to 3/4" M.P. Male	2.87 72.9	1.12 28.4	20,000 137.9
Y5Y5-9-16C	9/16" M.P. Male to 1" M.P. Male	4.00 101.6	1.00 25.4	20,000 137.9
Y5Y5-12-12C	3/4" M.P. Male to 3/4" M.P. Male	3.00 76.2	1.12 28.4	20,000 137.9
Y5Y5-12-16C	3/4" M.P. Male to 1" M.P. Male	1.25 31.8	1.12 28.4	20,000 137.9



Adapters

**Adapters**

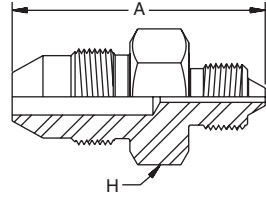
**Y5Y6 – Male medium pressure to male high pressure**



Adapters

#		A			
		inch mm	inch mm	psi MPa	
Y5Y6-4-4C	1/4" M.P. Male to 1/4" H.P. Male	1.73 43.9	0.63 16.0	20,000 137.9	
Y5Y6-4-6C	1/4" M.P. Male to 3/8" H.P. Male	2.10 53.3	0.75 19.1	20,000 137.9	
Y5Y6-4-9C	1/4" M.P. Male to 9/16" H.P. Male	2.37 60.2	1.12 28.4	20,000 137.9	
Y5Y6-6-4C	3/8" M.P. Male to 1/4" H.P. Male	2.12 53.8	0.62 15.7	20,000 137.9	
Y5Y6-6-9C	3/8" M.P. Male to 9/16" H.P. Male	2.50 63.5	1.12 28.4	20,000 137.9	
Y5Y6-9-4C	9/16" M.P. Male to 1/4" H.P. Male	2.25 57.2	0.87 22.1	20,000 137.9	
Y5Y6-9-9C	9/16" M.P. Male to 9/16" H.P. Male	2.62 66.5	1.12 28.4	20,000 137.9	
Y5Y6-12-4C	3/4" M.P. Male to 1/4" H.P. Male	2.62 66.5	1.12 28.4	20,000 137.9	
Y5Y6-12-6C	3/4" M.P. Male to 3/8" H.P. Male	2.75 69.9	1.12 28.4	20,000 137.9	
Y5Y6-12-9C	3/4" M.P. Male to 9/16" H.P. Male	3.00 76.2	1.12 28.4	20,000 137.9	
Y5Y6-16-4C	1" M.P. Male to 1/4" H.P. Male	3.62 91.9	1.00 25.4	20,000 137.9	
Y5Y6-16-6C	1" M.P. Male to 3/8" H.P. Male	4.00 101.6	1.00 25.4	20,000 137.9	
Y5Y6-16-9C	1" M.P. Male to 9/16" H.P. Male	4.00 101.6	1.12 28.4	20,000 137.9	

**Y501 – Male medium pressure to NPT male**

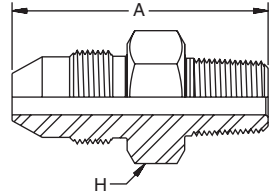

#		A				
					inch	psi
		mm	mm	MPa		
Y501-4-4C	1/4" M.P. Male to 1/4" NPT Male	1.60 40.6	0.63 16.0	15,000 103.4		
Y501-4-8C	1/4" M.P. Male to 1/2" NPT Male	2.12 53.8	0.87 22.1	15,000 103.4		
Y501-6-4C	3/8" M.P. Male to 1/4" NPT Male	2.06 52.3	0.75 19.1	15,000 103.4		
Y501-6-6C	3/8" M.P. Male to 3/8" NPT Male	2.06 52.3	0.75 19.1	15,000 103.4		
Y501-6-8C	3/8" M.P. Male to 1/2" NPT Male	2.18 55.4	0.87 22.1	15,000 103.4		
Y501-9-2C	9/16" M.P. Male to 1/8" NPT Male	2.12 53.8	0.87 22.1	15,000 103.4		
Y501-9-4C	9/16" M.P. Male to 1/4" NPT Male	2.25 57.2	0.87 22.1	15,000 103.4		
Y501-9-6C	9/16" M.P. Male to 3/8" NPT Male	2.25 57.2	0.87 22.1	15,000 103.4		
Y501-9-8C	9/16" M.P. Male to 1/2" NPT Male	2.37 60.2	0.87 22.1	15,000 103.4		
Y501-9-12C	9/16" M.P. Male to 3/4" NPT Male	2.62 66.5	1.12 28.4	10,000 68.9		
Y501-9-16C	9/16" M.P. Male to 1" NPT Male	2.62 66.5	1.37 34.8	10,000 68.9		
Y501-12-2C	3/4" M.P. Male to 1/8" NPT Male	2.37 60.2	1.12 28.4	15,000 103.4		
Y501-12-4C	3/4" M.P. Male to 1/4" NPT Male	2.50 63.5	1.12 28.4	15,000 103.4		
Y501-12-6C	3/4" M.P. Male to 3/8" NPT Male	2.50 63.5	1.12 28.4	15,000 103.4		
Y501-12-8C	3/4" M.P. Male to 1/2" NPT Male	2.62 66.5	1.12 28.4	15,000 103.4		
Y501-12-12C	3/4" M.P. Male to 3/4" NPT Male	2.75 69.9	1.12 28.4	10,000 68.9		
Y501-12-16C	3/4" M.P. Male to 1" NPT Male	3.00 76.2	1.37 34.8	10,000 68.9		

(continued)

Adapters

**Adapters**

**Y501 – Male medium pressure to NPT male  
(continued)**

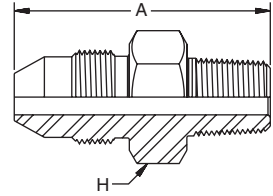

#		A		H	
		inch mm	inch mm	psi MPa	
Y501-16-2C	1" M.P. Male to 1/8" NPT Male	3.62 91.9	1.00 25.4	15,000 103.4	
Y501-16-4C	1" M.P. Male to 1/4" NPT Male	3.75 95.2	1.00 25.4	15,000 103.4	
Y501-16-6C	1" M.P. Male to 3/8" NPT Male	3.75 95.2	1.00 25.4	15,000 103.4	
Y501-16-8C	1" M.P. Male to 1/2" NPT Male	3.87 98.3	1.00 25.4	15,000 103.4	
Y501-16-12C	1" M.P. Male to 3/4" NPT Male	3.87 98.3	1.12 28.4	10,000 68.9	
Y501-16-16C	1" M.P. Male to 1" NPT Male	4.00 101.6	1.37 34.8	10,000 68.9	

Adapters

### L5Y – Medium pressure elbow

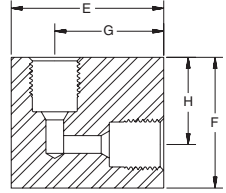

#			E	F	G	H	
			inch mm	inch mm	inch mm	inch mm	
L5Y-4C	1/4" M.P.	0.75 19.1	1.18 30.0	1.00 25.4	0.87 22.1	0.68 17.3	20,000 137.9
L5Y-6C	3/8" M.P.	0.75 19.1	1.37 34.8	1.37 34.8	1.00 25.4	1.00 25.4	20,000 137.9
L5Y-9C	9/16" M.P.	1.00 25.4	1.75 44.5	1.75 44.5	1.25 31.8	1.25 31.8	20,000 137.9
L5Y-12C	3/4" M.P.	1.37 34.8	2.25 57.2	2.25 57.2	1.50 38.1	1.50 38.1	20,000 137.9
L5Y-16C	1" M.P.	1.75 44.5	3.00 76.2	3.00 76.2	2.06 52.3	2.06 52.3	20,000 137.9

### T5Y – Medium pressure elbow

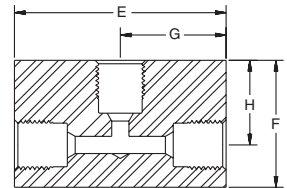

#			E	F	G	H	
			inch mm	inch mm	inch mm	inch mm	
T5Y-4C	1/4" M.P.	0.62 15.7	1.75 44.5	1.00 25.4	0.87 22.1	0.68 17.3	20,000 137.9
T5Y-6C	3/8" M.P.	0.75 19.1	2.00 50.8	1.37 34.8	1.00 25.4	1.00 25.4	20,000 137.9
T5Y-9C	9/16" M.P.	1.00 25.4	2.50 63.5	1.75 44.5	1.25 31.8	1.25 31.8	20,000 137.9
T5Y-12C	3/4" M.P.	1.37 34.8	3.00 76.2	2.25 57.2	1.50 38.1	1.50 38.1	20,000 137.9
T5Y-16C	1" M.P.	1.75 44.5	4.12 104.6	3.00 76.2	2.06 52.3	2.06 52.3	20,000 137.9

Adapters

**Adapters**

**X5Y – Medium pressure elbow**

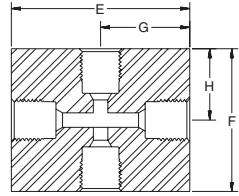

#			E	F	G	H	
			inch mm	inch mm	inch mm	inch mm	
X5Y-4C	1/4" M.P.	0.62 15.7	1.75 44.5	1.37 34.8	0.87 22.1	0.68 17.3	20,000 137.9
X5Y-6C	3/8" M.P.	0.75 19.1	2.00 50.8	2.00 50.8	1.00 25.4	1.00 25.4	20,000 137.9
X5Y-9C	9/16" M.P.	1.00 25.4	2.50 63.5	2.50 63.5	1.25 31.8	1.25 31.8	20,000 137.9
X5Y-12C	3/4" M.P.	1.37 34.8	3.00 76.2	3.00 76.2	1.50 38.1	1.50 38.1	20,000 137.9
X5Y-16C	1" M.P.	1.75 44.5	4.12 104.6	4.12 104.6	2.06 52.3	2.06 52.3	20,000 137.9

Adapters

**Y2N – Medium pressure gland nut**

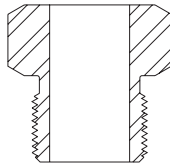

**Y2C – Medium pressure collar**

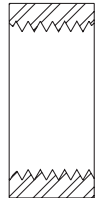



#			psi MPa
			psi MPa
Y2N-4C	1/4" M.P.	20,000 137.9	20,000 137.9
Y2N-6C	3/8" M.P.	20,000 137.9	20,000 137.9
Y2N-9C	9/16" M.P.	20,000 137.9	20,000 137.9
Y2N-12C	3/4" M.P.	20,000 137.9	20,000 137.9
Y2N-16C	1" M.P.	20,000 137.9	20,000 137.9

#			psi MPa
			psi MPa
Y2C-4C	1/4" M.P.	20,000 137.9	20,000 137.9
Y2C-6C	3/8" M.P.	20,000 137.9	20,000 137.9
Y2C-9C	9/16" M.P.	20,000 137.9	20,000 137.9
Y2C-12C	3/4" M.P.	20,000 137.9	20,000 137.9
Y2C-16C	1" M.P.	20,000 137.9	20,000 137.9

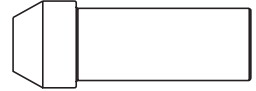
## HBPLM – Medium pressure plug



#		
		psi MPa
HBPLM4-B	1/4" M.P.	20,000 137.9
HBPLM6-B	3/8" M.P.	20,000 137.9
HBPLM9-B	9/16" M.P.	20,000 137.9
HBPLM12-B	3/4" M.P.	20,000 137.9
HBPLM16-B	1" M.P.	20,000 137.9

## Y204, Y206, Y209, Y212 and Y216 – Medium pressure nipple

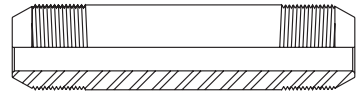

Length	#	#	#	#	#
inch mm	1/4" O.D.	3/8" O.D.	9/16" O.D.	3/4" O.D.	1" O.D.
2.75 69.9	Y204-0275C	–	–	–	–
3.00 72.2	Y204-0300C	Y206-0300C	–	–	–
4.00 101.6	Y204-0400C	Y206-0400C	Y209-0400C	Y212-0400C	–
6.00 152.4	Y204-0600C	Y206-0600C	Y209-0600C	Y212-0600C	Y216-0600C
8.00 203.2	Y204-0800C	Y206-0800C	Y209-0800C	Y212-0800C	Y216-0800C
10.00 254.0	Y204-1000C	Y206-1000C	Y209-1000C	Y212-1000C	Y216-1000C
12.00 304.8	Y204-1200C	Y206-1200C	Y209-1200C	Y212-1200C	Y216-1200C

## High pressure

### Sizes

1/4" O.D. x 0.08" I.D. • 9/16" - 18 male thread on gland nut  
3/8" O.D. x 0.12" I.D. • 3/4" - 16 male thread on gland nut  
9/16" O.D. x 0.18" I.D. • 1 1/8" - 12 male thread on gland nut

Identification is by tubing O.D.

### Construction

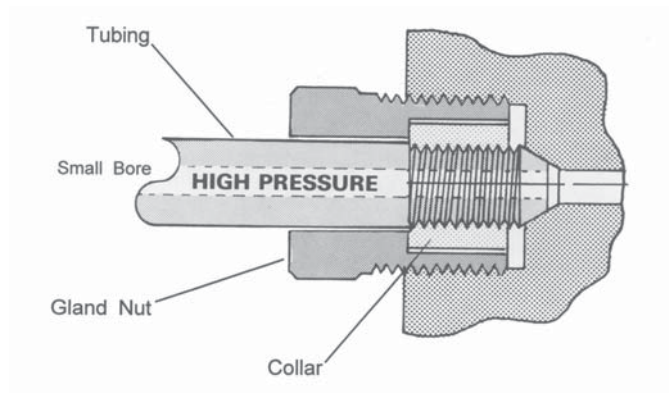

**High Pressure** is a 58/60 degree coned and threaded tubing design.



***With small bore sizes, they have a maximum working pressure rating of 60,000 psi.***

### Advantages

- An industry standard for use at elevated pressures.
- Suitable for repetitive assembly and disassembly.

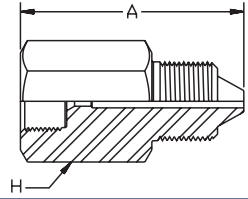
**6YY6 – Female high pressure to male high pressure**



#		A			
		inch mm	inch mm	inch mm	psi MPa
6YY6-4-6C	1/4" H.P. Female to 3/8" H.P.	1.75 44.5	0.75 19.1	60,000 413.7	
6YY6-4-9C	1/4" H.P. Female to 9/16" H.P.	2.12 53.8	1.12 28.4	60,000 413.7	
6YY6-6-4C	3/8" H.P. Female to 1/4" H.P.	1.50 38.1	1.00 25.4	60,000 413.7	
6YY6-6-9C	3/8" H.P. Female to 9/16" H.P.	2.12 53.8	1.12 28.4	60,000 413.7	
6YY6-9-4C	9/16" H.P. Female to 1/4" H.P.	1.75 44.5	1.37 34.8	60,000 413.7	
6YY6-9-9C	9/16" H.P. Female to 3/8" H.P.	1.87 47.5	1.37 34.8	60,000 413.7	

**Adapters**

Adapters

6Y01 – Female high pressure to male NPT

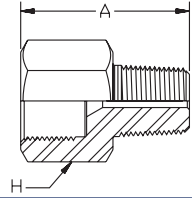

Adapters

#		A			
		inch mm	inch mm	inch mm	psi MPa
6Y01-4-2C	1/4" H.P. Female to 1/8" NPT	1.25 31.8	0.75 19.1	15,000 103.4	
6Y01-4-4C	1/4" H.P. Female to 1/4" NPT	1.37 34.8	0.75 19.1	15,000 103.4	
6Y01-4-6C	1/4" H.P. Female to 3/8" NPT	1.37 34.8	0.75 19.1	15,000 103.4	
6Y01-4-8C	1/4" H.P. Female to 1/2" NPT	1.75 44.5	1.00 25.4	15,000 103.4	
6Y01-4-12C	1/4" H.P. Female to 3/4" NPT	1.75 44.5	1.37 38.4	10,000 68.9	
6Y01-4-16C	1/4" H.P. Female to 1" NPT	1.62 41.1	1.37 38.4	10,000 68.9	
6Y01-6-2C	3/8" H.P. Female to 1/8" NPT	1.50 38.1	1.00 25.4	15,000 103.4	
6Y01-6-4C	3/8" H.P. Female to 1/4" NPT	1.62 41.1	1.00 25.4	15,000 103.4	
6Y01-6-6C	3/8" H.P. Female to 3/8" NPT	1.62 41.1	1.00 25.4	15,000 103.4	
6Y01-6-8C	3/8" H.P. Female to 1/2" NPT	1.75 44.5	1.00 25.4	15,000 103.4	
6Y01-6-12C	3/8" H.P. Female to 3/4" NPT	1.87 47.5	1.37 38.4	10,000 68.9	
6Y01-6-16C	3/8" H.P. Female to 1" NPT	1.87 47.5	1.37 38.4	10,000 68.9	
6Y01-9-2C	9/16" H.P. Female to 1/8" NPT	1.50 38.1	1.37 38.4	15,000 103.4	
6Y01-9-4C	9/16" H.P. Female to 1/4" NPT	1.62 41.1	1.27 32.3	15,000 103.4	
6Y01-9-6C	9/16" H.P. Female to 3/8" NPT	1.75 44.5	1.37 38.4	15,000 103.4	
6Y01-9-8C	9/16" H.P. Female to 1/2" NPT	1.87 47.5	1.37 38.4	15,000 103.4	
6Y01-9-12C	9/16" H.P. Female to 3/4" NPT	1.87 47.5	1.37 38.4	10,000 68.9	
6Y01-9-16C	9/16" H.P. Female to 1" NPT	2.00 50.8	1.37 38.4	10,000 68.9	

**02Y6 – Female NPT to male high pressure**

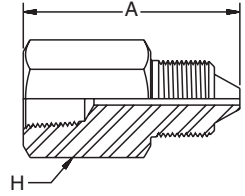





#		A			
		inch mm	inch mm		
02Y6-2-4C	1/8" NPT to 1/4" H.P.	1.62 41.1	0.75 19.1	15,000 103.4	
02Y6-2-6C	1/8" NPT to 3/8" H.P.	1.62 41.1	0.75 19.1	15,000 103.4	
02Y6-2-9C	1/8" NPT to 9/16" H.P.	2.12 53.8	1.12 28.4	15,000 103.4	
02Y6-4-4C	1/4" NPT to 1/4" H.P.	1.75 44.5	0.75 19.1	15,000 103.4	
02Y6-4-6C	1/4" NPT to 3/8" H.P.	1.75 44.5	0.75 19.1	15,000 103.4	
02Y6-4-9C	1/4" NPT to 9/16" H.P.	2.12 53.8	1.12 28.4	15,000 103.4	
02Y6-6-4C	3/8" NPT to 1/4" H.P.	1.75 44.5	1.00 25.4	15,000 103.4	
02Y6-6-6C	3/8" NPT to 3/8" H.P.	1.75 44.5	1.00 25.4	15,000 103.4	
02Y6-6-9C	3/8" NPT to 9/16" H.P.	2.12 53.8	1.12 28.4	15,000 103.4	
02Y6-8-4C	1/2" NPT to 1/4" H.P.	2.12 53.8	1.12 28.4	15,000 103.4	
02Y6-8-6C	1/2" NPT to 3/8" H.P.	2.12 53.8	1.12 28.4	15,000 103.4	
02Y6-8-9C	1/2" NPT to 9/16" H.P.	2.12 53.8	1.12 28.4	15,000 103.4	
02Y6-12-6C	3/4" NPT to 3/8" H.P.	1.50 38.1	1.62 41.1	10,000 68.9	
02Y6-12-9C	3/4" NPT to 9/16" H.P.	2.25 57.2	1.37 34.8	10,000 68.9	
02Y6-16-9C	1" NPT to 9/16" H.P.	2.0 50.8	2.75 69.9	10,000 68.9	

Adapters

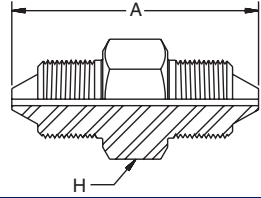
**Adapters**

**Y6Y6 – Male high pressure to male high pressure**



#		A			
		inch mm	inch mm	inch mm	psi MPa
Y6Y6-4-4C	1/4" H.P. to 1/4" H.P.	1.68 42.7	0.62 15.7	60,000 413.7	60,000 413.7
Y6Y6-4-6C	1/4" H.P. to 3/8" H.P.	2.06 52.3	0.75 19.1	60,000 413.7	60,000 413.7
Y6Y6-4-9C	1/4" H.P. to 9/16" H.P.	2.25 57.2	1.12 28.4	60,000 413.7	60,000 413.7
Y6Y6-6-6C	3/8" H.P. to 3/8" H.P.	2.25 57.2	0.75 19.1	60,000 413.7	60,000 413.7
Y6Y6-6-9C	3/8" H.P. to 9/16" H.P.	2.50 63.5	1.12 28.4	60,000 413.7	60,000 413.7
Y6Y6-9-9C	9/16" H.P. to 9/16" H.P.	2.62 66.5	1.12 28.4	60,000 413.7	60,000 413.7

Adapters

**Y601 – Male high pressure to male NPT**

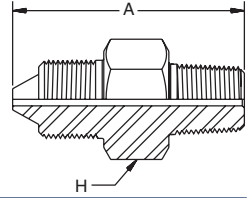



#		A			
		inch mm	inch mm	inch mm	psi MPa
Y601-4-2C	1/4" H.P. to 1/8" NPT	1.87 47.5	0.62 15.7	15,000 103.4	
Y601-4-4C	1/4" H.P. to 1/4" NPT	2.06 52.3	0.75 19.1	15,000 103.4	
Y601-4-6C	1/4" H.P. to 3/8" NPT	2.00 50.8	0.75 19.1	15,000 103.4	
Y601-4-8C	1/4" H.P. to 1/2" NPT	2.12 53.8	0.87 22.1	15,000 103.4	
Y601-4-12C	1/4" H.P. to 3/4" NPT	2.25 57.2	1.12 28.4	10,000 68.9	
Y601-6-4C	1/4" H.P. to 1" NPT	2.12 53.8	0.87 22.1	15,000 103.4	
Y601-6-6C	3/8" H.P. to 1/8" NPT	2.12 53.8	0.87 22.1	15,000 103.4	
Y601-9-4C	3/8" H.P. to 1/4" NPT	2.37 60.2	1.12 28.4	15,000 103.4	
Y601-9-6C	3/8" H.P. to 3/8" NPT	2.37 60.2	1.12 28.4	15,000 103.4	
Y601-9-8C	3/8" H.P. to 1/2" NPT	2.50 63.5	1.12 28.4	15,000 103.4	
Y601-9-12C	3/8" H.P. to 3/4" NPT	2.62 66.5	1.12 28.4	10,000 68.9	
Y601-9-16C	3/8" H.P. to 1" NPT	2.75 69.9	1.37 34.8	10,000 68.9	

Adapters

**Adapters**

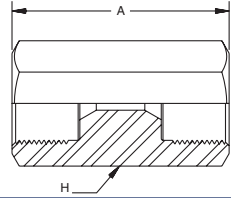
**6Y6Y – Straight coupling**

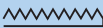



#		A			
		inch mm	inch mm	inch mm	psi MPa
6Y6Y-4-4C	1/4" H.P.	1.75 44.5	1.00 25.4	60,000 413.7	
6Y6Y-6-6C	3/8" H.P.	2.00 50.8	1.00 25.4	60,000 413.7	
6Y6Y-9-9C	9/16" H.P.	2.37 60.2	1.37 34.8	60,000 413.7	

Adapters

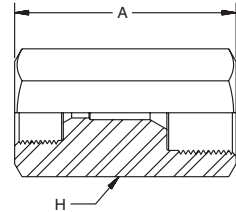

**6Y6Y – Reducer coupling**

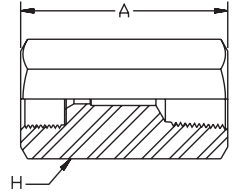

#		A			
		inch mm	inch mm	inch mm	psi MPa
6Y6Y-4-6C	1/4" H.P. to 3/8" H.P.	1.62 41.1	1.00 25.4	60,000 413.7	
6Y6Y-4-9C	1/4" H.P. to 9/16" H.P.	1.75 44.5	1.37 34.8	60,000 413.7	
6Y6Y-6-9C	3/8" H.P. to 9/16" H.P.	2.00 50.8	1.37 34.8	60,000 413.7	

## 6Y02 – Female high pressure to female NPT coupling





#		A			
		inch mm	inch mm	inch mm	psi MPa
6Y02-4-2C	1/4" H.P. to 1/8" NPT	1.50 38.1	1.00 25.4	15,000 103.4	
6Y02-4-4C	1/4" H.P. to 1/4" NPT	1.50 38.1	1.00 25.4	15,000 103.4	
6Y02-4-6C	1/4" H.P. to 3/8" NPT	1.87 47.5	1.00 25.4	15,000 103.4	
6Y02-4-8C	1/4" H.P. to 1/2" NPT	1.87 47.5	1.12 28.4	15,000 103.4	
6Y02-4-12C	1/4" H.P. to 3/4" NPT	2.00 50.8	1.62 41.1	10,000 68.9	
6Y02-4-16C	1/4" H.P. to 1" NPT	2.50 63.5	1.75 44.5	10,000 68.9	
6Y02-6-2C	3/8" H.P. to 1/8" NPT	1.87 47.5	1.00 25.4	15,000 103.4	
6Y02-6-4C	3/8" H.P. to 1/4" NPT	1.87 47.5	1.00 25.4	15,000 103.4	
6Y02-6-6C	3/8" H.P. to 3/8" NPT	1.87 47.5	1.00 25.4	15,000 103.4	
6Y02-6-8C	3/8" H.P. to 1/2" NPT	1.87 47.5	1.12 28.4	15,000 103.4	
6Y02-6-12C	3/8" H.P. to 3/4" NPT	2.12 53.8	1.37 34.8	10,000 68.9	
6Y02-6-16C	3/8" H.P. to 1" NPT	2.50 63.5	1.75 44.5	10,000 68.9	
6Y02-9-2C	9/16" H.P. to 1/8" NPT	2.37 60.2	1.37 34.8	15,000 103.4	
6Y02-9-4C	9/16" H.P. to 1/4" NPT	2.37 60.2	1.37 34.8	15,000 103.4	
6Y02-9-6C	9/16" H.P. to 3/8" NPT	2.37 60.2	1.37 34.8	15,000 103.4	
6Y02-9-8C	9/16" H.P. to 1/2" NPT	2.37 60.2	1.37 34.8	15,000 103.4	
6Y02-9-12C	9/16" H.P. to 3/4" NPT	2.37 60.2	1.37 34.8	10,000 68.9	
6Y02-9-16C	9/16" H.P. to 1" NPT	2.62 66.5	2.00 50.8	10,000 68.9	

**Adapters**

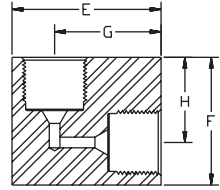
**L6Y – High pressure elbow**





#			E	F	G	H		
			inch mm	inch mm	inch mm	inch mm		inch mm
<b>L6Y-4C</b>	1/4" H.P.		1.00	1.37	1.50	0.87	1.00	60,000
			25.4	34.8	38.1	22.1	25.4	413.7
<b>L6Y-6C</b>	3/8" H.P.		1.00	1.75	1.50	1.25	1.00	60,000
			25.4	44.5	38.1	31.8	25.4	413.7
<b>L6Y-9C</b>	9/16" H.P.		1.50	2.62	1.87	1.12	1.12	60,000
			38.1	66.5	47.5	28.4	28.4	413.7

Adapters

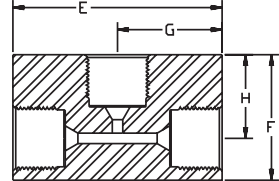
**T6Y – High pressure tee**



#			E	F	G	H		
			inch mm	inch mm	inch mm	inch mm		inch mm
<b>T6Y-4C</b>	1/4" H.P.		1.00	1.37	1.37	1.00	0.87	60,000
			25.4	34.8	34.8	25.4	22.1	413.7
<b>T6Y-6C</b>	3/8" H.P.		1.00	1.75	1.56	1.00	1.06	60,000
			25.4	44.5	39.6	25.4	26.9	413.7
<b>T6Y-9C</b>	9/16" H.P.		1.50	2.62	2.12	1.62	1.37	60,000
			38.1	66.5	53.8	41.1	34.8	413.7

**X6Y – High pressure cross**

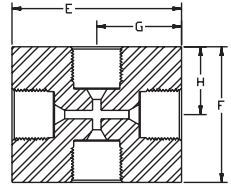

#			E	F	G	H	
			inch mm	inch mm	inch mm	inch mm	
X6Y-4C	1/4" H.P.	1.00 25.4	2.00 50.8	1.50 38.1	1.00 25.4	0.75 19.1	60,000 413.7
X6Y-6C	3/8" H.P.	1.00 25.4	2.12 53.8	2.00 50.8	1.06 26.9	1.00 25.4	60,000 413.7
X6Y-9C	9/16" H.P.	1.50 38.1	2.75 69.9	2.62 66.5	1.37 34.8	1.31 33.3	60,000 413.7

**Y4N – High pressure gland nut**

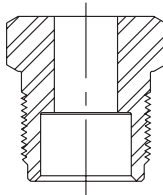

#			psi MPa
			psi MPa
Y4N-4C	1/4" H.P.	60,000 413.7	
Y4N-6C	3/8" H.P.	60,000 413.7	
Y4N-9C	9/16" H.P.	60,000 413.7	

**Y4C – High pressure collar**

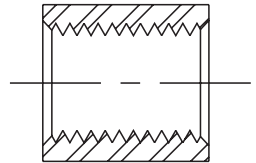

#			psi MPa
			psi MPa
Y4C-4C	1/4" H.P.	60,000 413.7	
Y4C-6C	3/8" H.P.	60,000 413.7	
Y4C-9C	9/16" H.P.	60,000 413.7	

**Adapters**

**HBPHM – High pressure plug**

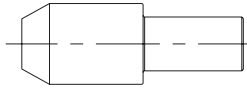

**Locking nut/collar – Anti-vibration**

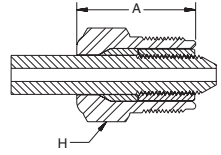

#		
		psi MPa
HBPHM4-B	1/4" H.P.	60,000 413.7
HBPHM6-B	3/8" H.P.	60,000 413.7
HBPHM9-B	9/16" H.P.	60,000 413.7

#		F	
	inch mm	inch mm	inch mm
Y4NC-4C-AV	1/4" H.P.	0.68 17.3	0.63 16.0
Y4NC-6C-AV	3/8" H.P.	1.06 26.9	0.68 17.3
Y4NC-9C-AV	9/16" H.P.	1.56 39.6	1.68 42.7

Adapters

**Nipples – High pressure**



Length	#	#	#
inch mm	1/4" O.D.	3/8" O.D.	9/16" O.D.
2.75 69.9	Y404-0275C	—	Y409-0275C
3.00 76.2	Y404-0300C	Y406-0300C	—
4.00 101.6	Y404-0400C	—	Y409-0400C
6.00 152.4	Y404-0600C	Y406-0600C	Y409-0600C
8.00 203.2	Y404-0800C	Y406-0800C	Y409-0800C
10.00 254.0	Y404-1000C	Y406-1000C	Y409-1000C
12.00 304.8	Y404-1200C	Y406-1200C	Y409-1200C

---

## National Pipe Tapered (NPT)

### Scope

---





**polyflex**<sup>™</sup> offers a broad range of high quality stainless steel high pressure NPT adapters. Sizes 1/8" to 1/2" are rated up to 15,000 psi, 3/4" and above are rated to 10,000 psi.

**Adapters**

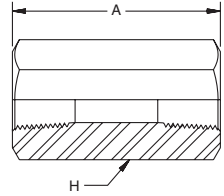

**K0202 – NPT coupler**

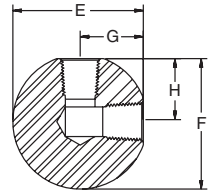

#		A	H		
			inch mm	inch mm	
15K0202-2-2C	1/8" NPT Female	1.50 38.1	0.75 19.1	15,000 103.4	
15K0202-4-4C	1/4" NPT Female	1.75 44.5	0.87 22.1	15,000 103.4	
15K0202-6-6C	3/8" NPT Female	1.75 44.5	1.00 25.4	15,000 103.4	
15K0202-8-8C	1/2" NPT Female	2.13 54.1	1.25 31.8	15,000 103.4	
10K0202-12-12C	3/4" NPT Female	2.13 54.1	1.50 38.1	10,000 68.9	
10K0202-16-16C	1" NPT Female	2.50 63.5	2.00 50.8	10,000 68.9	

**KL02 – NPT elbow**





#			E	F	G	H	
			inch mm	inch mm	inch mm	inch mm	
15KL02-4C	1/4" NPT Female	1.15 29.1	1.70 43.2	1.70 43.2	0.80 20.3	0.80 20.3	15,000 103.4
15KL02-6C	3/8" NPT Female	1.38 35.1	1.90 48.3	1.90 48.3	0.90 22.9	0.90 22.9	15,000 103.4
15KL02-8C	1/2" NPT Female	1.63 41.4	2.15 54.6	2.15 54.6	1.03 26.2	1.03 26.2	15,000 103.4
10KL02-12C	3/4" NPT Female	2.05 52.1	1.85 47.0	1.85 47.0	1.35 34.3	1.35 34.3	10,000 68.9
10KL02-16C	1" NPT Female	2.50 63.5	3.83 97.3	3.83 97.3	1.82 46.2	1.82 46.2	10,000 68.9

Adapters

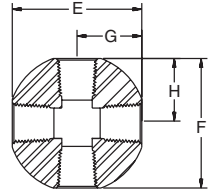
**KX02 – NPT cross**

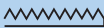



#			E	F	G	H	
			inch mm	inch mm	inch mm	inch mm	
15KX02-4C	1/4" NPT Female	1.15 29.2	1.60 40.6	1.60 40.6	0.80 20.3	0.80 20.3	15,000 103.4
15KX02-6C	3/8" NPT Female	1.38 35.1	1.80 45.7	1.80 45.7	0.90 22.9	0.90 22.9	15,000 103.4
15KX02-8C	1/2" NPT Female	1.63 41.4	2.05 52.1	2.05 52.1	1.03 26.2	1.03 26.2	15,000 103.4
10KX02-12C	3/4" NPT Female	2.05 52.1	2.70 68.6	2.70 68.6	1.35 34.3	1.35 34.3	10,000 68.9
10KX02-16C	1" NPT Female	2.50 63.5	3.63 92.2	3.63 92.2	1.82 46.2	1.82 46.2	10,000 68.9

Adapters

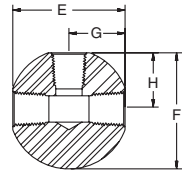
**KT02 – NPT tee**





#			E	F	G	H	
			inch mm	inch mm	inch mm	inch mm	
15KT02-4C	1/4" NPT Female	1.15 29.2	1.60 40.6	1.70 43.2	0.80 20.3	1.15 29.2	15,000 103.4
15KT02-6C	3/8" NPT Female	1.38 35.1	1.80 45.7	1.90 48.3	0.90 22.9	1.38 35.1	15,000 103.4
15KT02-8C	1/2" NPT Female	1.63 41.4	2.05 52.1	2.15 54.6	1.03 26.2	1.63 41.4	15,000 103.4
10KT02-12C	3/4" NPT Female	2.05 52.1	2.70 68.6	1.85 47.0	1.35 34.3	2.05 52.1	10,000 68.9
10KT02-16C	1" NPT Female	2.50 63.5	3.63 92.2	3.83 97.3	1.82 46.2	2.50 63.5	10,000 68.9

**Adapters**

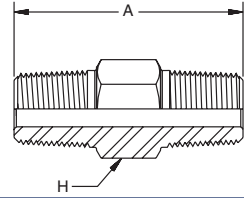
**K0101 – NPT nipple**

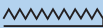



#		A			
		inch mm	inch mm		
15K0101-1-1C	1/16" NPT Male	1.00 25.4	0.38 9.7	15,000 103.4	
15K0101-2-2C	1/8" NPT Male	1.20 30.5	0.50 12.7	15,000 103.4	
15K0101-4-4C	1/4" NPT Male	1.44 36.6	0.63 16.0	15,000 103.4	
15K0101-6-6C	3/8" NPT Male	1.70 43.2	0.75 19.1	15,000 103.4	
15K0101-8-8C	1/2" NPT Male	2.25 57.2	1.00 25.4	15,000 103.4	
10K0101-12-12C	3/4" NPT Male	2.44 62.0	1.13 28.7	10,000 68.9	
10K0101-16-16C	1" NPT Male	2.75 69.9	1.38 35.1	10,000 68.9	

Adapters

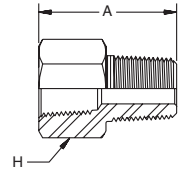
**K0201 – NPT reducer bushing**



#		A			
		inch mm	inch mm		
15K0201-1-8C	1/16" NPT Female to 1/2" NPT Male	1.25 31.8	0.87 22.1	15,000 103.4	
15K0201-2-8C	1/8" NPT Female to 1/2" NPT Male	1.25 31.8	0.87 22.1	15,000 103.4	
15K0201-4-8C	1/4" NPT Female to 1/2" NPT Male	1.25 31.8	0.87 22.1	15,000 103.4	
15K0201-6-8C	3/8" NPT Female to 1/2" NPT Male	1.63 41.4	1.00 25.4	15,000 103.4	

## Valves

Medium Pressure — up to 20,000 psi

High Pressure — up to 60,000 psi

## Scope

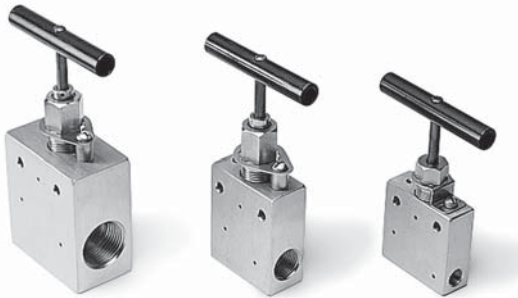

Developed to assure safe and easy plumbing through 60,000 psi. These needle valves are engineered to the highest standards of repeatable quality. The medium pressure valves are designed with a compact cone-and-threaded connection which permits the larger bore sizes and increased flow rates common in this pressure class. The high pressure valves also use a coned-and-threaded connection which accommodates the high pressures common in these applications.

Non-rotating tip stems are standard for on-off service and insure long life on valve seats.

Materials include high tensile type 316 stainless steel bodies and hardened 17-4PH stainless steel lower section stems.

Packing is TFE standard with optional Viton®, BUNA-N and Grafoil available as non-standard.

Two Way Straight valves are standard with five additional patterns to satisfy widely varied requirements are available on request.

## Features

- Non-Rotating Stem Tips
- Packing Below Stem Threads
- Type 316 ss high tensile bodies
- Positive gland lock device
- No stem adjustment needed
- Black T-handles standard or choice of 4 colors (special order)
- Tube sizes

Medium Pressure — 1/4" through 1"

High Pressure — 1/4" through 9/16"

## SV5Y – Two way straight valves Medium Pressure (M.P.) – 20,000 psi

#		Orifice		
		inch mm	inch mm	
SV5Y-4C-20	1/4" M.P.	0.10 2.5	0.75 19.1	20,000 137.9
SV5Y-6C-20	3/8" M.P.	0.20 5.1	0.75 19.1	20,000 137.9
SV5Y-9C-20	9/16" M.P.	0.31 7.9	1.00 25.4	20,000 137.9
SV5Y-12C-20	3/4 M.P.	0.51 13.0	1.37 34.8	20,000 137.9
SV5Y-16C-20	1" M.P.	0.68 17.3	1.75 44.5	20,000 137.9

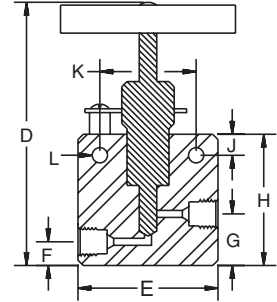



**Dimensions**

#	D	E	F	G	H	J	K	L
	inch mm	inch mm	inch mm	inch mm	inch mm	inch mm	inch mm	inch mm
SV5Y-4C-20	4.37 111.0	2.00 50.8	0.37 9.4	0.81 20.6	2.00 50.8	0.37 9.4	1.25 31.8	0.21 5.3
SV5Y-6C-20	4.37 111.0	2.00 50.8	0.37 9.4	0.81 20.6	2.00 50.8	0.37 9.4	1.25 31.8	0.21 5.3
SV5Y-9C-20	6.12 155.4	2.50 63.5	0.50 12.7	1.12 28.4	2.87 72.9	0.50 12.7	1.37 34.8	0.34 8.6
SV5Y-12C-20	7.00 177.8	3.00 76.2	0.75 19.1	1.50 38.1	3.75 95.3	0.62 15.7	1.75 44.5	0.43 10.9
SV5Y-16C-20	8.42 213.9	4.12 106.6	0.87 22.1	1.81 46.0	4.62 117.3	1.12 28.4	2.50 63.5	0.56 14.2

Adapters

**AV5Y – Two way angle valves**  
Medium Pressure (M.P.) – 20,000 psi

#		Orifice		
			inch mm	inch mm
AV5Y-4C-20	1/4" M.P.	0.10 2.5	0.75 19.1	20,000 137.9
AV5Y-6C-20	3/8" M.P.	0.20 5.1	0.75 19.1	20,000 137.9
AV5Y-9C-20	9/16" M.P.	0.31 7.9	1.00 25.4	20,000 137.9
AV5Y-12C-20	3/4" M.P.	0.51 13.0	1.37 34.8	20,000 137.9
AV5Y-16C-20	1" M.P.	0.68 17.3	1.75 44.5	20,000 137.9

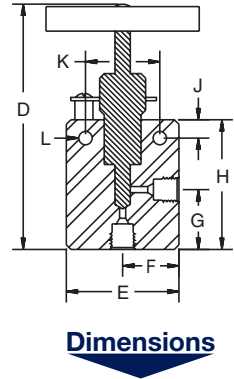

#	D	E	F	G	H	J	K	L
	inch mm	inch mm	inch mm	inch mm	inch mm	inch mm	inch mm	inch mm
AV5Y-4C-20	4.81 122.2	2.00 50.8	1.00 25.4	1.25 31.8	2.43 61.7	0.37 9.4	1.25 31.8	0.21 5.3
AV5Y-6C-20	4.81 122.2	2.00 50.8	1.00 25.4	1.25 31.8	2.43 61.7	0.37 9.4	1.25 31.8	0.21 5.3
AV5Y-9C-20	6.62 168.1	2.50 63.5	1.25 31.8	1.62 41.1	3.37 85.6	0.50 12.7	1.37 34.8	0.34 8.6
AV5Y-12C-20	7.50 190.5	3.00 76.2	1.50 38.1	2.00 50.8	4.25 108.0	0.62 15.7	1.75 44.5	0.43 10.9
AV5Y-16C-20	9.37 236.5	4.12 104.6	2.06 52.3	2.56 65.0	5.43 137.9	1.12 28.4	2.50 63.5	0.56 14.2

Adapters

**Valves**

**TV25Y – Three way valves**  
**Medium Pressure (M.P.) – 20,000 psi**  
**Two pressure connections**

#		Orifice		
		inch mm	inch mm	
TV25Y-4C-20	1/4" M.P.	0.10 2.5	0.75 19.1	20,000 137.9
TV25Y-6C-20	3/8" M.P.	0.20 5.1	0.75 19.1	20,000 137.9
TV25Y-9C-20	9/16" M.P.	0.31 7.9	1.00 25.4	20,000 137.9
TV25Y-12C-20	3/4" M.P.	0.51 13.0	1.37 34.8	20,000 137.9
TV25Y-16C-20	1" M.P.	0.68 17.3	1.75 44.5	20,000 137.9

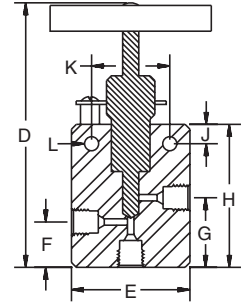

**Dimensions**

Adapters

#	D	E	F	G	H	J	K	L
	inch mm	inch mm	inch mm	inch mm	inch mm	inch mm	inch mm	inch mm
TV25Y-4C-20	5.00 127.0	2.00 50.8	1.00 25.4	1.43 36.3	2.62 66.5	0.37 9.4	1.25 31.8	0.21 5.3
TV25Y-6C-20	5.00 127.0	2.00 50.8	1.00 25.4	1.43 36.3	2.62 66.5	0.37 9.4	1.25 31.8	0.21 5.3
TV25Y-9C-20	6.87 174.5	2.50 63.5	1.25 31.8	1.87 47.5	3.62 91.9	0.50 12.7	1.37 34.8	0.34 8.6
TV25Y-12C-20	7.87 199.9	3.00 76.2	2.62 66.5	2.37 60.2	4.62 117.3	0.62 15.7	1.75 44.5	0.43 10.9
TV25Y-16C-20	9.75 247.7	4.12 104.6	2.12 53.8	3.06 77.7	5.87 149.1	1.12 28.4	2.50 63.5	0.56 14.2

**TV15Y – Three way valves**  
Medium Pressure (M.P.) – 20,000 psi  
One pressure connection

#		Orifice		
			inch mm	inch mm
TV15Y-4C-20	1/4" M.P.	0.10 2.5	0.75 19.1	20,000 137.9
TV15Y-6C-20	3/8" M.P.	0.20 5.1	0.75 19.1	20,000 137.9
TV15Y-9C-20	9/16" M.P.	0.31 7.9	1.00 25.4	20,000 137.9
TV15Y-12C-20	3/4" M.P.	0.51 13.0	1.37 34.8	20,000 137.9
TV15Y-16C-20	1" M.P.	0.68 17.3	1.75 44.5	20,000 137.9

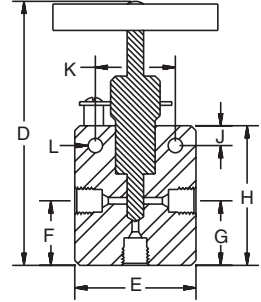

**Dimensions**



Adapters

#	D	E	F	G	H	J	K	L
	inch mm	inch mm	inch mm	inch mm	inch mm	inch mm	inch mm	inch mm
TV15Y-4C-20	4.81 122.2	2.00 50.8	1.25 31.8	1.25 31.8	2.43 61.7	0.37 9.4	1.25 31.8	0.21 5.3
TV15Y-6C-20	4.81 122.2	2.00 50.8	1.25 31.8	1.25 31.8	2.43 61.7	0.37 9.4	1.25 31.8	0.21 5.3
TV15Y-9C-20	6.62 168.1	2.50 63.5	1.62 41.1	1.62 41.1	3.37 85.6	0.50 12.7	1.37 34.8	0.34 8.6
TV15Y-12C-20	7.50 190.5	3.00 76.2	2.00 50.8	2.00 50.8	4.25 108.0	0.62 15.7	1.75 44.5	0.43 10.9
TV15Y-16C-20	9.37 236.5	4.12 104.6	2.62 52.3	2.62 52.3	5.43 137.9	1.12 28.4	2.50 63.5	0.56 14.2

**Valves**

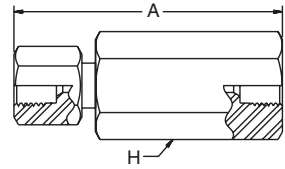

**CV5Y – Ball check valves**  
**Medium Pressure (M.P.) – 20,000 psi**



#		A			
		inch mm	inch mm		
CV5Y-4C-20	1/4" M.P.	3.75 95.3	1.00 25.4	20,000 137.9	
CV5Y-6C-20	3/8" M.P.	3.75 95.3	1.00 25.4	20,000 137.9	
CV5Y-9C-20	9/16" M.P.	4.35 110.5	1.37 34.8	20,000 137.7	

Adapters

**SV6Y – Two way straight valves**  
High Pressure (H.P.) – 30,000 psi

#		Orifice		
			inch mm	inch mm
SV6Y-4C-30	1/4" H.P.	0.09 2.3	1.00 25.4	30,000 206.8
SV6Y-6C-30	3/8" H.P.	0.12 3.0	1.00 25.4	30,000 206.8
SV6Y-9C-30	9/16" H.P.	0.12 3.0	1.50 38.1	30,000 206.8

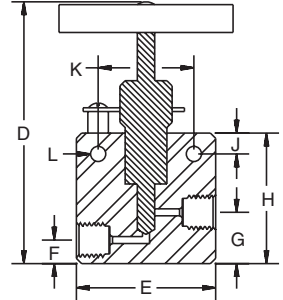



**Dimensions**

#	D	E	F	G	H	J	K	L
	inch mm	inch mm	inch mm	inch mm	inch mm	inch mm	inch mm	inch mm
SV6Y-4C-30	5.18 131.6	2.00 50.8	0.62 15.7	1.00 25.4	2.43 61.7	0.50 12.7	1.37 34.8	0.21 5.3
SV6Y-6C-30	5.18 131.6	2.00 50.8	0.62 15.7	1.00 25.4	2.43 61.7	0.50 12.7	1.37 34.8	0.21 5.3
SV6Y-9C-30	5.62 142.7	2.62 66.5	1.00 25.4	1.43 36.3	2.87 72.9	0.50 12.7	1.37 34.8	0.21 5.3

Adapters

## AV6Y – Two way angle valves

High Pressure (H.P.) – 30,000 psi

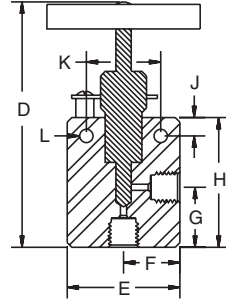

#		Orifice		
		inch mm	inch mm	
AV6Y-4C-30	1/4" H.P.	0.09 2.3	1.00 25.4	30,000 206.8
AV6Y-6C-30	3/8" H.P.	0.12 3.0	1.00 25.4	30,000 206.8
AV6Y-9C-30	9/16" H.P.	0.12 3.0	1.50 38.1	30,000 206.8



**Dimensions**

#	D	E	F	G	H	J	K	L
	inch mm	inch mm	inch mm	inch mm	inch mm	inch mm	inch mm	inch mm
AV6Y-4C-30	5.18 131.6	2.00 50.8	1.00 25.4	1.00 25.4	2.43 61.7	0.50 12.7	1.37 34.8	0.21 5.3
AV6Y-6C-30	5.56 141.2	2.00 50.8	1.00 25.4	1.37 34.8	2.81 71.4	0.50 12.7	1.37 34.8	0.21 5.3
AV6Y-9C-30	5.62 142.7	2.62 66.5	1.31 33.3	1.43 36.3	2.87 72.9	0.50 12.7	1.37 34.8	0.21 5.3

**TV26Y – Three way valves**  
High Pressure (H.P.) – 30,000 psi  
Two pressure connections

#		Orifice		
			inch mm	inch mm
TV26Y-4C-30	1/4" H.P.	0.09 2.3	1.00 25.4	30,000 206.8
TV26Y-6C-30	3/8" H.P.	0.12 3.0	1.00 25.4	30,000 206.8
TV26Y-9C-30	9/16" H.P.	0.12 3.0	1.50 38.1	30,000 206.8

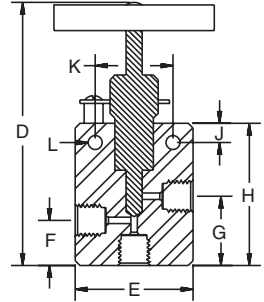



**Dimensions**

Adapters

#	D	E	F	G	H	J	K	L
	inch mm	inch mm	inch mm	inch mm	inch mm	inch mm	inch mm	inch mm
TV26Y-4C-30	5.18 131.6	2.00 50.8	0.62 15.7	1.00 25.4	2.43 61.7	0.50 12.7	1.37 34.8	0.21 5.3
TV26Y-6C-30	5.56 141.2	2.00 50.8	1.00 25.4	1.37 34.8	2.81 71.4	0.50 12.7	1.37 34.8	0.21 5.3
TV26Y-9C-30	6.06 153.9	2.62 66.5	1.43 36.3	1.87 47.5	3.31 84.1	0.50 12.7	1.37 34.8	0.21 5.3

**TV16Y – Three way valves**  
**High Pressure (H.P.) – 30,000 psi**  
**One pressure connection**

#		Orifice		
		inch mm	inch mm	
TV16Y-4C-30	1/4" H.P.	0.09 2.3	1.00 25.4	30,000 206.8
TV16Y-6C-30	3/8" H.P.	0.12 3.0	1.00 25.4	30,000 206.8
TV16Y-9C-30	9/16" H.P.	0.12 3.0	1.50 38.1	30,000 206.8

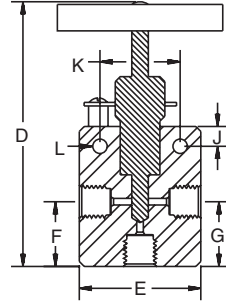



**Dimensions**

#	D	E	F	G	H	J	K	L
	inch mm	inch mm	inch mm	inch mm	inch mm	inch mm	inch mm	inch mm
TV16Y-4C-30	5.18 131.6	2.00 50.8	1.00 25.4	1.00 25.4	2.43 61.7	0.50 12.7	1.37 34.8	0.21 5.3
TV16Y-6C-30	5.56 141.2	2.00 50.8	2.00 50.8	1.43 36.3	2.81 71.4	0.50 12.7	1.37 34.8	0.21 5.3
TV16Y-9C-30	5.62 142.7	2.62 66.5	2.18 55.4	1.43 36.3	2.87 72.9	0.50 12.7	1.37 34.8	0.21 5.3

Adapters

**SV6Y – Two way straight valves**  
High Pressure (H.P.) – 60,000 psi

#		Orifice		
			inch mm	inch mm
SV6Y-4C-60	1/4" H.P.	0.06	1.00	60,000
			1.5	25.4
SV6Y-6C-60	3/8" H.P.	0.06	1.00	60,000
			1.5	25.4
SV6Y-9C-60	9/16" H.P.	0.06	1.50	60,000
			1.5	38.1

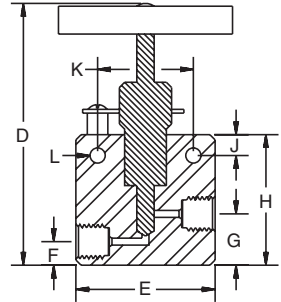



**Dimensions**

#	D	E	F	G	H	J	K	L
	inch mm	inch mm	inch mm	inch mm	inch mm	inch mm	inch mm	inch mm
SV6Y-4C-60	5.18	2.00	0.62	1.00	2.43	0.50	1.37	0.21
	131.6	50.8	15.7	25.4	61.7	12.7	34.8	5.3
SV6Y-6C-60	5.18	2.00	0.62	1.00	2.43	0.50	1.37	0.21
	131.6	50.8	15.7	25.4	61.7	12.7	34.8	5.3
SV6Y-9C-60	5.62	2.62	1.00	1.43	2.87	0.50	1.37	0.21
	142.7	66.5	25.4	36.1	72.9	12.7	34.8	5.3

Adapters

## AV6Y – Two way angle valves

### High Pressure (H.P.) – 60,000 psi

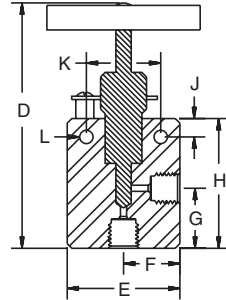

#		Orifice		
		inch	mm	
AV6Y-4C-60	1/4" H.P.	0.06	1.00	60,000
		1.5	25.4	413.7
AV6Y-6C-60	3/8" H.P.	0.06	1.00	60,000
		1.5	25.4	413.7
AV6Y-9C-60	9/16" H.P.	0.06	1.50	60,000
		1.5	38.1	413.7



Dimensions

#	D	E	F	G	H	J	K	L
	inch	inch	inch	inch	inch	inch	inch	inch
	mm	mm	mm	mm	mm	mm	mm	mm
AV6Y-4C-60	5.18	2.00	1.00	1.00	2.43	0.50	1.37	0.21
	131.6	50.8	25.4	25.4	61.7	12.7	34.8	5.3
AV6Y-6C-60	5.56	2.00	1.00	1.37	2.81	0.50	1.37	0.21
	141.2	50.8	25.4	34.8	71.4	12.7	34.8	5.3
AV6Y-9C-60	5.62	2.62	1.31	1.43	2.87	0.50	1.37	0.21
	141.7	66.5	33.3	36.3	72.9	12.7	34.8	5.3

**TV26Y – Three way valves**  
High Pressure (H.P.) – 60,000 psi  
Two pressure connections

#		Orifice		
			inch mm	inch mm
TV26Y-4C-60	1/4" H.P.	0.06 1.5	1.00 25.4	60,000 413.7
TV26Y-6C-60	3/8" H.P.	0.06 1.5	1.00 25.4	60,000 413.7
TV26Y-9C-60	9/16" H.P.	0.06 1.5	1.50 38.1	60,000 413.7

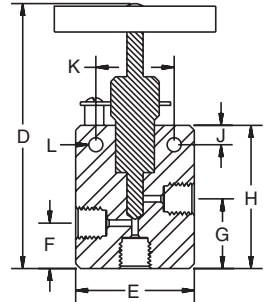



**Dimensions**

#	D	E	F	G	H	J	K	L
	inch mm	inch mm	inch mm	inch mm	inch mm	inch mm	inch mm	inch mm
TV26Y-4C-60	5.18 131.6	2.00 50.8	0.62 15.7	1.00 25.4	2.43 61.7	0.50 12.7	1.37 34.8	0.21 5.3
TV26Y-6C-60	5.56 141.6	2.00 50.8	1.00 25.4	1.37 34.8	2.81 71.4	0.50 12.7	1.37 34.8	0.21 5.3
TV26Y-9C-60	6.06 153.9	2.62 66.5	1.43 36.3	1.87 47.5	3.31 84.1	0.50 12.7	1.37 34.8	0.21 5.3

Adapters

**TV16Y – Three way valves**  
**High Pressure (H.P.) – 60,000 psi**  
**One pressure connection**

#		Orifice			
		inch	mm		
TV16Y-4C-60	1/4" H.P.	0.06	1.00	inch	psi
		1.5	25.4	mm	MPa
TV16Y-6C-60	3/8" H.P.	0.06	1.00	inch	psi
		1.5	25.4	mm	MPa
TV16Y-9C-60	9/16" H.P.	0.06	1.50	inch	psi
		1.5	38.1	mm	MPa

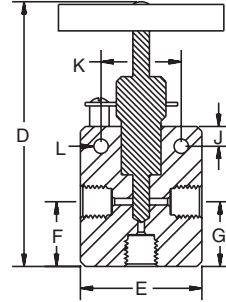





**Dimensions**

Adapters

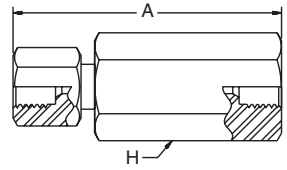
#	D	E	F	G	H	J	K	L
	inch	inch	inch	inch	inch	inch	inch	inch
	mm	mm	mm	mm	mm	mm	mm	mm
TV16Y-4C-60	5.18	2.00	1.00	1.00	2.43	0.50	1.37	0.21
	131.6	50.8	25.4	25.4	61.7	12.7	34.8	5.3
TV16Y-6C-60	5.56	2.00	2.00	1.43	2.81	0.50	1.37	0.21
	141.6	50.8	50.8	36.3	71.4	12.7	34.8	5.3
TV16Y-9C-60	5.62	2.62	2.18	1.43	2.87	0.50	1.37	0.21
	142.7	66.5	55.4	36.3	72.9	12.7	34.8	5.3

**CV6Y – Ball check valves**  
High Pressure (H.P.)



#		A			
		inch mm	inch mm		
CV6Y-4C-60	1/4" H.P.	4.18 106.2	1.50 38.1	60,000 413.7	
CV6Y-6C-60	3/8" H.P.	4.25 108.0	1.50 38.1	60,000 413.7	
CV6Y-9C-60	9/16" H.P.	4.62 117.3	1.56 39.6	60,000 413.7	



**Chapter H****Quick couplers****Rogan series —****30,000 psi maximum working pressure**

HP006 Coupler.....	H-3
HP006 Nipple (without check valve) .....	H-4
HP006 Nipple (with check valve).....	H-5
HP010 Coupler.....	H-6
HP010 Nipple (without check valve) .....	H-7
HP010 Nipple (with check valve).....	H-8

**C Series hydraulic couplers —****29,800 psi maximum working pressure**

115 Coupler.....	H-10
115 Nipple.....	H-11
116 Coupler.....	H-12
116 Nipple.....	H-13
125 Coupler.....	H-13
125 Nipple.....	H-14
Adapters.....	H-15

## Rogan series

### Scope

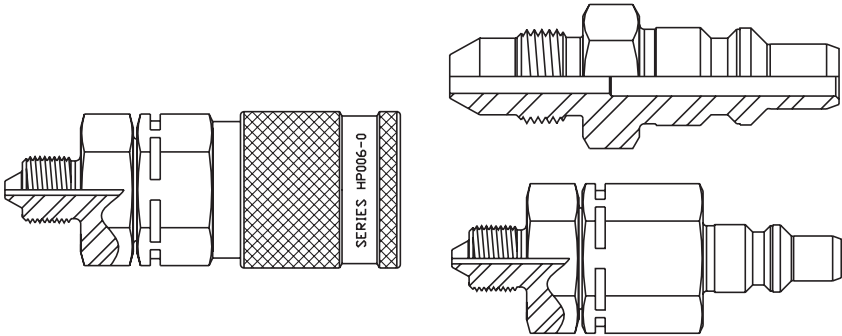

A versatile connecting device that permits easy and rapid joining of hose assemblies to your system. Each coupling is assembled and pressure tested to at least 5,000 psi above its maximum rated working pressure. Couplings with check-valve can withstand the full working pressure in the disconnected condition.

### Types and pressures

Type	Max. working pressure (psi/MPa)	Test pressure (psi/MPa)	Nominal thru hole diameter (inch/mm)
HP006	30,000 / 206.8	35,000 / 241.3	0.24 / 6.1
HP010	20,000 / 137.9	25,000 / 172.4	0.40 / 10.2

NOTE: The choice of the threaded end form may limit the working pressure and the size of the thru hole in the coupling. Call **polyflex**™ for additional information.



## HP006 – Coupler

#		A			
		inch mm	inch mm		
HP006-0-A9	Type "M" (9/16" - 18 threads)	3.30 83.8	1.19 30.2	30,000 206.8	
HP006-0-A12	Type "M" (3/4" - 16 threads)	3.34 84.8	1.19 30.2	30,000 206.8	
HP006-0-HM4	1/4" High pressure male	3.46 87.9	1.19 30.2	30,000 206.8	
HP006-0-HM9	9/16" High pressure male	3.70 94.9	1.19 30.2	30,000 206.8	
HP006-0-LM6	3/8" Medium pressure male	3.54 89.9	1.19 30.2	20,000 137.9	
HP006-0-NFB	1/4" NPT Female	3.30 83.8	1.19 30.2	15,000 103.4	
HP006-0-NFC	3/8" NPT Female	3.30 83.8	1.19 30.2	15,000 103.4	
HP006-0-NMB	1/4" NPT Male	3.40 86.4	1.19 30.2	15,000 103.4	
HP006-0-NMC	3/8" NPT Male	3.30 83.8	1.19 30.2	15,000 103.4	
HP006-0-NMD	1/2" NPT Male	3.45 87.6	1.19 30.2	15,000 103.4	
HP006-0-X13	Low angle face seal (9/16" - 18 threads)	3.37 85.6	1.19 30.2	30,000 206.8	

Quick couplers

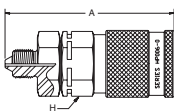

HP006-0-HM4

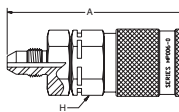

HP006-0-LM6

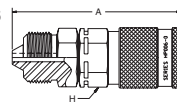

HP006-0-HM9

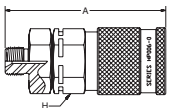

HP006-0-A9  
HP006-0-A12

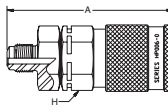

HP006-0-X13

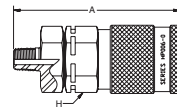

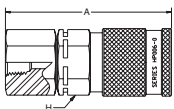

HP006-0-NMB  
HP006-0-NMC  
HP006-0-NMD



HP006-0-NFB  
HP006-0-NFC

## HP006 – Nipple without check valve

#		A			
		inch mm	inch mm		
HP006-1-A9	Type "M" (9/16" - 18 threads)	1.98 50.3	0.75 19.1	30,000 206.8	
HP006-1-A12	Type "M" (3/4" - 16 threads)	2.16 54.9	0.87 22.1	30,000 206.8	
HP006-1-HM4	1/4" High pressure male	2.25 57.2	0.75 19.1	30,000 206.8	
HP006-1-LM6	3/8" Medium pressure male	2.33 59.2	0.75 19.1	20,000 137.9	
HP006-1-LM9	9/16" Medium pressure male	2.57 65.3	1.00 25.4	20,000 137.9	
HP006-1-NMB	1/4" NPT Male	2.09 53.1	0.75 19.1	15,000 103.4	
HP006-1-NMC	3/8" NPT Male	2.13 54.1	0.75 19.1	15,000 103.4	
HP006-1-NMD	1/2" NPT Male	2.31 58.7	1.00 25.4	15,000 103.4	
HP006-1-X13	Low angle face seal (9/16" - 18 threads)	2.17 55.1	0.75 19.1	30,000 206.8	

Quick couplers

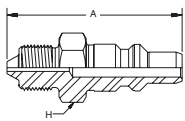

HP006-1-HM4

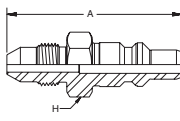

HP006-1-LM6  
HP006-1-LM9

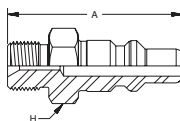

HP006-1-A9  
HP006-1-A12

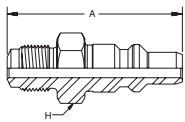

HP006-1-X13

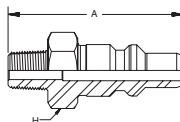

HP006-1-NMB  
HP006-1-NMC  
HP006-1-NMD



## HP006 – Nipple with check valve

#		A		
			inch mm	inch mm
HP006-2-A9	Type "M" (9/16" - 18 threads)	3.28 83.3	1.19 30.2	30,000 206.8
HP006-2-A12	Type "M" (3/4" - 16 threads)	3.30 83.8	1.19 30.2	30,000 206.8
HP006-2-HM4	1/4" High pressure male	3.45 87.6	1.19 30.2	30,000 206.8
HP006-2-LM6	3/8" Medium pressure male	3.52 89.4	1.19 30.2	20,000 137.9
HP006-2-NFB	1/4" NPT Female	3.26 82.8	1.19 30.2	15,000 103.4
HP006-2-NFC	3/8" NPT Female	3.25 82.6	1.19 30.2	15,000 103.4
HP006-2-NMB	1/4" NPT Male	3.34 84.8	1.19 30.2	15,000 103.4
HP006-2-NMC	3/8" NPT Male	3.34 84.8	1.19 30.2	15,000 103.4
HP006-2-NMD	1/2" NPT Male	3.43 87.1	1.19 30.2	15,000 103.4
HP006-2-X13	Low angle face seal (9/16" - 18 threads)	3.35 85.1	1.19 30.2	30,000 206.8

Quick couplers

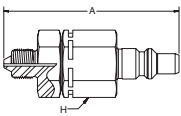

HP006-2-HM4

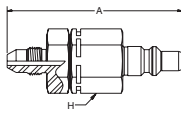

HP006-2-LM6

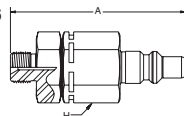

HP006-2-A9  
HP006-2-A12

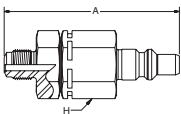

HP006-2-X13

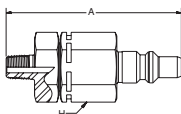

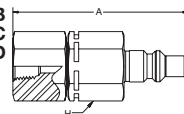

HP006-2-NMB  
HP006-2-NMC  
HP006-2-NMD



HP006-2-NFB  
HP006-2-NFC

## HP010 – Coupler

#		A			
		inch mm	inch mm		
HP010-0-A12	Type "M" (3/4" - 16 threads)	4.00 101.6	1.62 41.1	20,000 137.9	
HP010-0-A16	Type "M" (1" - 12 threads)	4.10 104.1	1.62 41.1	20,000 137.9	
HP010-0-LM12	3/4" Medium pressure male	4.64 117.9	1.62 41.1	20,000 137.9	
HP010-0-NFD	1/2" NPT Female	4.27 108.5	1.62 41.1	15,000 103.4	
HP010-0-NMD	1/2" NPT Male	4.13 104.9	1.62 41.1	15,000 103.4	
HP010-0-X23	Low angle face seal (3/4" - 16 threads)	4.19 106.4	1.62 41.1	20,000 137.9	

Quick couplers

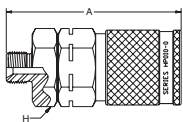

HP010-0-A12  
HP010-0-A16

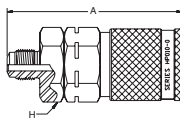

HP010-0-X23

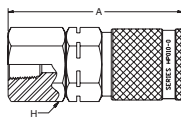

HP010-0-NFD

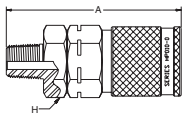

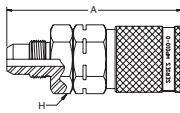

HP010-0-NMD



HP010-0-LM12



## HP010 – Nipple without check valve

#		A		
		inch mm	inch mm	psi MPa
HP010-1-A12	Type "M" (3/4" - 16 threads)	2.40 61.0	1.06 26.9	20,000 137.9
HP010-1-A16	Type "M" (1" - 12 threads)	2.53 64.3	1.18 30.0	20,000 137.9
HP010-1-LM9	9/16" Medium pressure male	3.12 79.2	1.18 30.0	20,000 137.9
HP010-1-LM12	3/4" Medium pressure male	2.84 72.1	1.06 26.9	20,000 137.9
HP010-1-NMD	1/2" NPT Male	2.52 64.0	1.06 26.9	15,000 103.4
HP010-1-X23	Low angle face seal (3/4" - 16 threads)	2.58 65.5	1.06 26.9	20,000 137.9

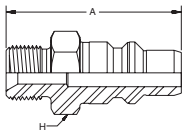

HP010-1-A12  
HP010-1-A16

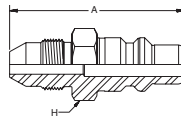

HP010-1-LM9  
HP010-1-LM12

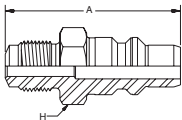

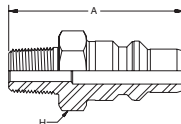

HP010-1-X23

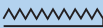

HP010-1-NMD

## HP010 – Nipple with check valve

#		A			
		inch mm	inch mm	psi MPa	
HP010-2-A12	Type "M" (3/4" - 16 threads)	4.00 101.6	1.62 41.1	20,000 137.9	
HP010-2-A16	Type "M" (1" - 12 threads)	4.08 103.6	1.62 41.1	20,000 137.9	
HP010-2-NFD	1/2" NPT Female	4.14 105.2	1.62 41.1	15,000 103.4	
HP010-2-NMD	1/2" NPT Male	4.13 104.9	1.62 41.1	15,000 103.4	
HP010-2-X23	Low angle face seal (3/4" - 16 threads)	4.18 106.2	1.62 41.1	20,000 137.9	

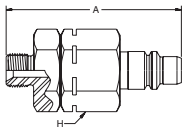

HP010-2-A12  
HP010-2-A16

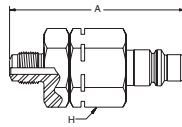

HP010-2-X23

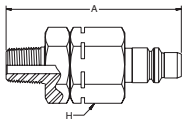

HP010-2-NMD

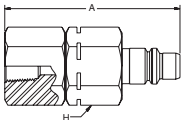

HP010-2-NFD

## C series

### Applications

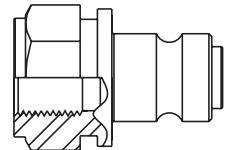
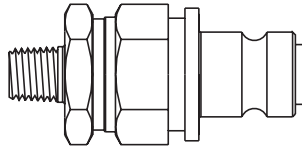
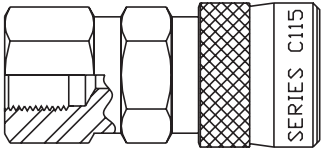

- Torque Tensioning
- Stud Tensioning
- Rescue
- Bearing Pullers
- Intensifiers
- Hydrostatic Testing
- Pumps
- Jacks
- Spreaders
- Cable Cutters
- Nut Splitters
- Pipe Coupling Swagers
- Presses
- Clamping Fixtures
- Crimpers
- Blow-out Preventers

### Features



- Working pressures to 29,000 psi.
- Non-drip valving for clean, safe, trouble-free performance and minimal air inclusion.
- Built-in safety locking device to prevent accidental disconnect.
- Wide range of threaded styles NPT, BSP and "High Pressure".
- Adaptors for ease of connection to high pressure hoses and fixed ports.
- Thread sizes from 1/8" to 3/8"
- Protective dust caps are included to prevent damage and fluid contamination in disconnected position.
- Rugged design and construction for long life in demanding applications.

### Types and pressures

Type	Max. working pressure (psi/MPa)	Test pressure (psi/MPa)	Nominal thru hole diameter (inch/mm)
C Series 115	14,500 / 100.0	21,800 / 150.3	0.11 / 2.8
C Series 116	21,800 / 150.3	29,200 / 201.3	0.11 / 2.8
C Series 125	29,800 / 205.5	36,300 / 250.3	0.11 / 2.8

NOTE: The choice of the threaded end form may limit the working pressure and the size of the thru hole in the coupling.

## 115 – Coupler

#		A			
		inch mm	inch mm	psi MPa	
C10-115-1202	1/4" BSP Female (thru type)	2.30 58.4	0.94 23.9	14,500 100.0	
C10-115-1222	1/4" BSP Female (with built-in locking device)	2.30 58.4	0.94 23.9	14,500 100.0	
C10-115-1401	1/8" NPT Female	2.30 58.4	0.94 23.9	14,500 100.0	
C10-115-1402	1/4" NPT Female	2.30 58.4	0.94 23.9	14,500 100.0	
C10-115-1404	3/8" NPT Female	2.38 60.5	0.94 23.9	14,500 100.0	
C10-115-1422	1/4" NPT Female (with built-in locking device)	2.30 58.4	0.94 23.9	14,500 100.0	
C10-115-1452	1/4" NPT Male	2.45 62.2	0.94 23.9	14,500 100.0	
C10-115-1454	3/8" NPT Male	2.45 62.2	0.94 23.9	14,500 100.0	

Quick couplers

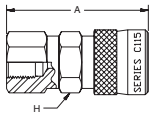

C10-115-1202

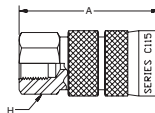

C10-115-1222

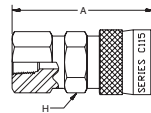

C10-115-1401

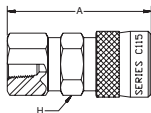

C10-115-1402

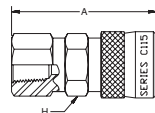

C10-115-1404

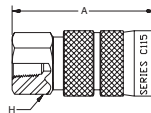

C10-115-1422

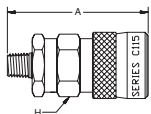

C10-115-1452

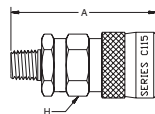



C10-115-1454

# 115 – Nipple

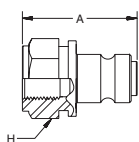
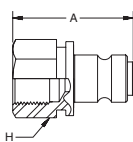
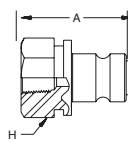
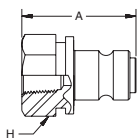
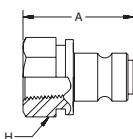
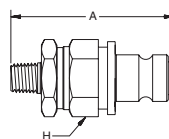
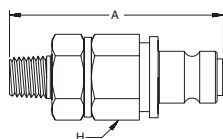
#		A			
		inch mm	inch mm	psi MPa	
C10-115-6202	1/4" BSP Female	1.47 37.3	0.87 22.1	14,500	100.0
C10-115-6204	3/8" BSP Female	1.56 39.6	0.94 23.9	14,500	100.0
C10-115-6401	1/8" NPT Female	1.42 37.3	0.87 22.1	14,500	100.0
C10-115-6402	1/4" NPT Female	1.42 37.3	0.87 22.1	14,500	100.0
C10-115-6404	3/8" NPT Female	1.46 37.1	0.94 23.9	14,500	100.0
C10-115-6452	1/4" NPT Male	2.40 61.0	0.87 22.1	14,500	100.0
C10-115-6454	3/8" NPT Male	2.55 64.8	0.94 23.9	14,500	100.0

**C10-115-6202**

**C10-115-6204**

**C10-115-6401**

**C10-115-6402**

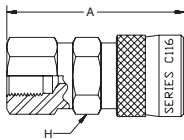
**C10-115-6404**

**C10-115-6452**

**C10-115-6454**
**Quick couplers**

# 116 – Coupler

#		A			
		inch mm	inch mm	psi MPa	
<b>C10-116-1202</b>	1/4" BSP Female	2.30 58.4	0.94 23.9	21,800 150.3	
<b>C10-116-1222</b>	1/4" BSP Female (with built-in locking device)	2.30 58.4	0.94 23.9	21,800 150.3	
<b>C10-116-1402</b>	1/4" NPT Female	2.30 58.4	0.94 23.9	15,000 103.4	
<b>C10-116-1422</b>	1/4" NPT Female (with built-in locking device)	2.30 58.4	0.94 23.9	15,000 103.4	

Quick couplers



**C10-116-1202**

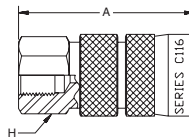

**C10-116-1222**

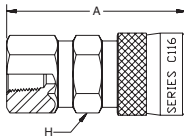

**C10-116-1402**

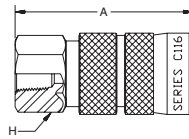

**C10-116-1422**

## 116 – Nipple

#		A			
		inch mm	inch mm		
C10-116-5202	1/4" BSP Female (thru type)	1.47 37.3	0.87 22.1	21,800 150.3	
C10-116-6202	1/4" BSP Female	1.47 37.3	0.87 22.1	21,800 150.3	
C10-116-6402	1/4" NPT Female	1.41 35.8	0.87 22.1	15,000 103.4	

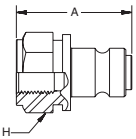
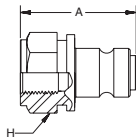
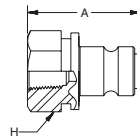

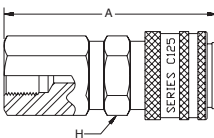

**C10-116-5202**

**C10-116-6202**

**C10-116-6402**

## 125 – Coupler

#		A			
		inch mm	inch mm		
C10-125-1202	1/4" BSP Female	2.65 67.3	0.94 23.9	29,000 199.9	

**C10-116-5202**

## 125 – Nipple

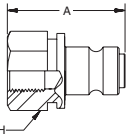

#		A			
		inch mm	inch mm	inch mm	psi MPa
C10-125-5202	1/4" BSP Female (thru type)	1.50 38.1	0.87 22.1		29,000 199.9
C10-125-6202	1/4" BSP Female	1.50 38.1	0.87 22.1		29,000 199.9

Quick couplers



C10-125-5202  
 C10-125-6202

## Quick coupling adapters

#		A			
		inch mm	inch mm		
<b>C09-125-1680</b>	1/4" BSP 120° external cone x 1/4" H.P. male	1.72 43.7	0.67 17.0	14,500 100.0	
<b>C19-950-0029</b>	1/4" BSP 120° ext. cone x 9/16" UNF hose	1.48 37.6	0.67 17.0	14,500 100.0	
<b>C19-950-0062</b>	1/4" BSP rubber metal seal	0.08 2.0	0.81 20.6	14,500 100.0	
<b>C19-950-0064</b>	3/8" BSP rubber metal seal	0.08 2.0	0.94 23.9	14,500 100.0	
<b>C19-950-1600</b>	1/4" BSP 120° external cone blind plug	1.07 27.2	0.67 17.0	14,500 100.0	
<b>C19-950-1601</b>	1/4" BSP x 1/4" BSP with 120° external cones	1.76 44.7	0.83 21.1	14,500 100.0	
<b>C19-950-1602</b>	1/4" BSP 120° ext. cone x 1/4" BSP 60° int. cone	1.54 39.1	0.83 21.1	14,500 100.0	
<b>C19-950-1622</b>	1/4" BSP x 1/4" BSP with 60° internal cones	1.25 31.8	0.83 21.1	14,500 100.0	
<b>C19-950-1623</b>	1/4" NPT Male x 1/4" BSP with 60° internal cone	1.27 32.3	0.83 21.1	14,500 100.0	
<b>C19-950-1680</b>	Porting block	1.80 45.7		14,500 100.0	
<b>HAHM4BM4</b>	1/4" BSP with 60° internal cone x 1/4" H.P. Male	1.47 37.3	0.83 21.1	14,500 100.0	

Quick couplers

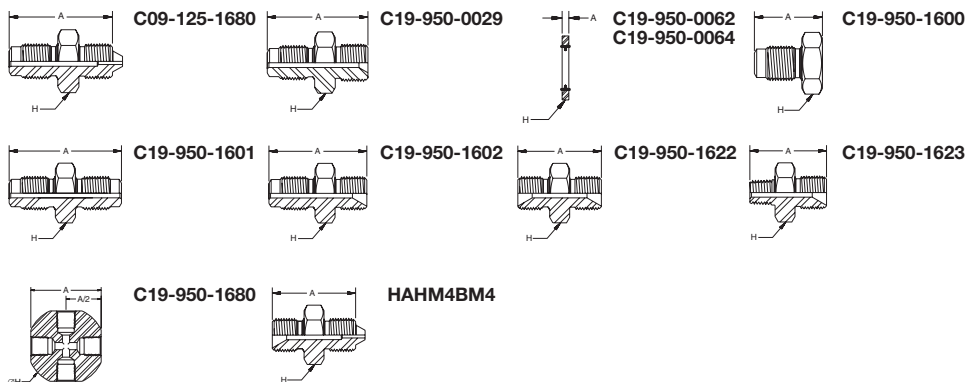



---

## Chapter I

### Accessories & tooling

Spring guards.....	I-2
Containment grips.....	I-2
Support grips .....	I-2
Anti-gall lubricant .....	I-2
Dies, HP fittings.....	I-3
Dies, HP guards .....	I-3
Gauges, HP fittings .....	I-3
Dies for <b>polyflex</b> <sup>®</sup> hose (2390N, 2245N, 57CR) .....	I-3
MiniKrimp, Parkrimp II and BSC-1 .....	I-4

## Spring guards



#	Description
MSG060	0.60" I.D. Continuous Spring
MSG1006	For 2040N-04V00 Hose
MSG2006	For 2245N-04V00 Hose
MSG2106	For 2380N-04v00 Hose
MSG4113	For -8 Hoses
MSG4120	For 2440n-12V37 Hose
MSG4125	For 2440N-16V37 Hose
MSG6020	For 2640N-12v32 Hose

## Containment grips



#	Description
MCG001SS	For Hose O.D. 0.38" - 0.69"
MCG002SS	For Hose O.D. 1.0" - 1.56"
MCG003SS	For Hose O.D. 1.25" - 1.94"
MCG005SS	For Hose O.D. 0.40" - 1.25"
MCGHS10-15	For Hose O.D. 0.75" - 0.59"
MCGHS15-20	For Hose O.D. 0.59" - 0.79"
MCGHS20-30	For Hose O.D. 0.79" - 1.18"
MCGHS30-40	For Hose O.D. 1.18" - 1.57"
MCGHS40-50	For Hose O.D. 1.57" - 1.96"
MCGHS50-60	For Hose O.D. 1.96" - 2.36"

## Support grips



#	Description
MK022-03-038	For Hose O.D. 0.63" - 0.74"
MK022-03-039	For Hose O.D. 0.75" - 0.99"
MK022-03-041	For Hose O.D. 1.00" - 1.24"
MK022-03-042	For Hose O.D. 1.25" - 1.49"
MK022-03-043	For Hose O.D. 1.50" - 1.74"
MK022-03-045	For Hose O.D. 2.25" - 2.49"

## ThreadMate™ Anti-gall lubricant



#	Description
MTM04T	4-oz Tube

- ThreadMate is an extreme duty lubricant developed to reduce galling during the assembly of threaded parts.
- ThreadMate promotes reliable sealing of pipe threads even at high pressure by reducing friction and galling during tightening, resulting in higher contact pressures of the sealing surfaces, and better metal-to-metal contact.
- ThreadMate reduces the torque needed to make pressure tight connections and tighten fasteners.

## Dies, HP fittings



#	Description
80C-HP3	Dies for HP3 Fittings
80C-HP4	Dies for HP4 Fittings
80C-HP6	Dies for HP6 Fittings

## Dies, HP guards



#	Description
80C-G03	Dies for HP3 Guards
80C-G04	Dies for HP4 Guards
80C-G06	Dies for HP6 Guards

## Gauges, HP fittings



#	Description
HP-3-Gauge	Gauge for HP-3 Fittings
HP-4-Gauge	Gauge for HP-4 Fittings
HP-6-Gauge	Gauge for HP-6 Fittings

## Dies for *polyflex* hose

- 2390N Hose series
- 2245N Hose series
- 57CR SeaWolf™



#	Description	Fitting series
83C-9X04	2390N-04	9x
83C-9X08	2390N-08	9X
83C-9X16	2390N-16	9X
80C-F04G	2245N-04V00	55
80C-F06G	2245N-06V00	58
80C-F08G	2245N-08V00	58
80C-F10G	2245N-10V30	58
80C-F12G	2245N-12V30	58
83C-F16G	2245N-16V30	58
80C-F08W	57CRN-08V	CR
83C-F16W	57CRN-16v	CR

## MiniKrimp™



### Standard Equipment Model 94C-001-PFD includes:

#	Description
94C-080-PFD	MiniKrimp™ Portable Crimping Machine
015301	Hand Pump
82C-R01-PFD	Die Ring – Color Coded Silver

The MiniKrimp is a portable, one piece crimping machine for hose assemblies up to -20.

Due to its light and very compact design the MiniKrimp is easy to transport and provides a cost effective way to make hose assemblies in the field.

The MiniKrimp is able to crimp the following fitting series:

55/56/57/58/91N and EH of the Polyflex division product range, 43/46/48 and 26 of the HPDE product range.

### Optional Equipment

#	Description
015736	Side Vise Mount
015306	Upright Table Mount
015307	Upright Vise Mount
82C-R02-PFD	Die Ring – Color Coded Black
015309	Hose Assembly
015308	Replacement Tube Assembly w/o Fittings

## Parkrimp II

Parkrimp II provides you with total capability to manufacture hydraulic hose assemblies up through 2". Parkrimp II's advanced design – with capacity to handle 100R1 through 100R14 hose types, coupled with straight or bent tube ends – is the industry's leading edge in the manufacture of hydraulic hose assemblies. Unparalleled in its design, Parkrimp II needs no special adjustments or gauge settings. Simply insert the unitized or split die train for the appropriate size – and with push button ease you have factory-quality assemblies in just seconds.



## BSC-1

BSC-1 is a portable hydraulic crimping machine for one-off production of hose assemblies up to 45mm crimping diameter.

Thanks to its lightness, the crimping machine suits especially well to traveling technicians and on-site service. It is operated with compressed air and comprises of a base, a crimping head and a power unit. The crimping machine is adjustable and not limited to use with a certain fitting series but can be used for all Polyflex fitting types. Dies are supplied in millimeter intervals.



#	Description
83C-081-PFD	For hose types 100R1 to 100R14

#	Description
BSC-1	for Polyflex hose fittings

---

**Chapter J****Technical information**

Parker engineering manual (PFDE-ES 29):	
Technical matrix for Parker <b>polyflex</b> <sup>®</sup> offshore hoses .....	J-2
Parker engineering manual (PFDE-ES 28):	
Recommended practices for handling, maintenance and inspection of long length Parker <b>polyflex</b> <sup>®</sup> offshore hoses and hose assemblies .....	J-6
Chemical resistance for Nylon 11 .....	J-9
General chemical resistance table .....	J-13
Pressure drop tables .....	J-17
Recommended tightening procedures.....	J-18
Parker safety guide .....	J-19
Glossary .....	J-26

## Parker engineering manual

### Technical matrix for Parker polyflex offshore hoses

Parker Publication No. PFDE-ES29  
Revised: March 2007

#### 1 SCOPE

This engineering standard contains the main information which is important for selection of hose for most of the offshore applications.

Guidelines for handling and storage of hose see PFDE-ES28.

#### 2 NOTES

Detailed information is available in appropriate hose specifications. They will always have precedence.

Most of the hoses have been fully qualified acc. to ISO 13268-5 for working pressures stated below or even at higher ones. Contact Parker for detailed information.

Working pressures stated below are based on safety factor 4:1.

Maximum lengths values are approximate ones. Most of them have been proven by manufacturing of hoses already.





Collapse pressures are typical values measured straight at ambient temperatures.

All values are valid for the hose assemblies, assembled with appropriate Parker fittings acc. to Parker assembly instructions.

**Hoses with methanol washed Nylon 11 core tube, multiple layers of steel wire and a Nylon outer jacket**





Working temperature for these hoses is -40°C to +100°C (-40°F to +212°F)

Chemical resistance of core tube see PFDE-ES28

#									Max length			Collapse pressure
	size DN	inch mm	inch mm	psi MPa	psi MPa	ft m	lbs/ft kg/m	psi MPa				
2240N-04V91	-04	1/4	0.46	6,250	25,000	11,500	0.114	1,740				
	6	6.4	11.6	43.0	172.5	3500	0.17	12.0				
2340N-04V91	-04	1/4	0.49	10,000	40,000	11,500	0.155	4,530				
	6	6.4	12.5	69.0	276.0	3500	0.23	30.0				
2380N-04V91	-04	1/4	0.53	10,000	40,000	10,500	0.181	3,630				
	6	6.4	13.4	69.0	276.0	3200	0.27	25.0				
2440N-04V91	-04	1/4	0.52	12,500	50,000	10,500	0.208	7,690				
	6	6.4	13.1	87.5	350.0	3200	0.31	53.0				
2448N-04V91	-04	1/4	0.54	15,000	60,000	9,850	0.255	7,980				
	6	6.4	13.7	103.5	414.0	3000	0.38	55.0				
2370N-06V91	-06	3/8	0.65	6,250	25,000	8,200	0.222	1,600				
	10	9.5	16.5	43.0	172.5	2500	0.33	11.0				
2380N-06V91*	-06	3/8	0.70	7,500	30,000	8,200	0.296	2,470				
	10	9.5	17.9	51.7	207.0	2500	0.44	17.0				
2390N-06V91	-06	3/8	0.71	6,450	25,800	10,500	0.276	2,180				
	10	9.5	18.1	44.5	178.0	3200	0.41	15.0				
2440N-06V91	-06	3/8	0.77	12,500	50,000	10,500	0.491	4,640				
	10	9.5	19.5	87.5	350.0	3200	0.73	32.0				
2448N-06V91*	-06	3/8	0.79	15,000	60,000	9,850	0.556	6,530				
	10	9.5	20.1	103.5	414.0	3000	0.83	45.0				
2380N-08V91*	-08	1/2	0.90	7,500	30,000	9,850	0.457	1,890				
	12	12.7	22.9	51.7	207.0	3000	0.68	13.0				
2390N-08V91	-08	1/2	0.83	6,000	24,000	11,500	0.383	1,740				
	12	12.7	21.2	41.5	166.0	3500	0.57	12.0				
2440N-08V91	-08	1/2	0.89	11,750	46,980	9,850	0.632	2,610				
	12	12.7	22.7	81.0	325.0	3000	0.94	18.0				
2580N-08V91	-08	1/2	0.99	12,500	50,000	9,200	0.800	3,190				
	12	12.7	25.2	87.5	350.0	2800	1.19	22.0				
2640N-08V91*	-08	1/2	0.97	15,000	60,000	9,200	0.900	4,350				
	12	12.7	24.7	103.5	414.0	2800	1.34	30.0				
2390N-12V91	-12	3/4	1.14	5,000	20,000	10,500	0.605	1,090				
	20	19.1	29.0	35.0	140.0	3200	0.90	7.5				
2440N-12V91	-12	3/4	1.19	9,135	36,250	6,550	0.988	1,450				
	20	19.1	30.2	63.0	250.0	2000	1.47	10.0				
2640N-12V91*	-12	3/4	1.31	12,500	50,000	5,900	1.451	2,610				
	20	19.1	33.2	87.5	350.0	1800	2.16	18.0				
2390N-16V91	-16	1	1.38	4,000	16,000	10,500	0.786	508				
	25	25.4	35.0	28.0	112.0	3200	1.17	3.5				
2440N-16V91	-16	1	1.46	8,120	32,480	6,550	1.277	940				
	25	25.4	37.2	56.0	225.0	2000	1.90	6.5				
2640N-16V91*	-16	1	1.58	10,875	43,500	5,900	1.908	1,160				
	25	25.4	40.2	75.0	300.0	1800	2.84	8.0				

\* these hoses have not been fully qualified yet. All values for these hoses are estimated ones.





Large bore hoses with additional TPU outer jacket "ColorGard™"

#									Max length			Collapse pressure
	size DN	inch mm	inch mm	psi MPa	psi MPa	ft m	lbs/ft kg/m	psi MPa				
2640N-24V80**	-24	1 1/2	2.76	10,000	33,350	4,900	4.838	740				
	40	38.1	70.0	69.0	230.0	1500	7.20	6.5				
2440N-32V80 "PHalcon"	-32	2	3.07	5,000	20,000	1,970	4.704	330				
	50	50.8	78.0	34.5	138.0	600	7.00	2.3				
2640N-32V80** "Black Eagle"	-32	2	3.31	10,000	25,000	1,970	6.182	360				
	50	50.8	84.0	69.0	172.5	600	9.20	2.5				

\* working pressures for these hoses are based on safety factors lower than 4:1.

ChemJec™ hoses with fluoropolymer core tube, multiple layers of steel wire and a Nylon outer jacket.

These hoses have an excellent chemical resistance against most of the aggressive chemicals. Working temperature is -40°C to +100°C (-40°F to +212°F)





#									Max length			Collapse pressure
	size DN	inch mm	inch mm	psi MPa	psi MPa	ft m	lbs/ft kg/m	psi MPa				
2240M-04V30	-04	1/4	0.46	6,250	25,000	11,500	0.114	2,470				
	6	6.4	11.6	43.0	172.5	3500	0.17	17.0				
2340M-04V30	-04	1/4	0.49	10,000	40,000	11,500	0.155	5,080				
	6	6.4	12.5	69.0	276.0	3500	0.23	35.0				
2380M-04V30	-04	1/4	0.53	10,000	40,000	10,500	0.181	4,250				
	6	6.4	13.4	69.0	276.0	3200	0.27	29.0				
2440M-04V30	-04	1/4	0.52	12,500	50,000	10,500	0.208	7,690				
	6	6.4	13.1	87.5	350.0	3200	0.31	53.0				
2448M-05V30	-05	5/16	0.64	15,000	60,000	8,200	0.349	6,230				
	8	7.9	16.2	103.5	414.0	2500	0.52	45.0				
2370M-06V30	-06	3/8	0.65	6,250	25,000	8,200	0.222	2,180				
	10	9.5	16.5	43.0	172.5	2500	0.33	15.0				
2440M-06V30*	-06	3/8	0.77	12,500	50,000	10,500	0.491	5,370				
	10	9.5	19.5	87.5	350.0	3200	0.73	37.0				
2448M-06V30*	-06	3/8	0.79	15,000	60,000	9,850	0.556	6,530				
	10	9.5	20.1	103.5	414.0	3000	0.83	45.0				
2440M-08V30*	-08	1/2	0.89	10,000	40,000	9,850	0.632	3,260				
	12	12.7	22.7	69.0	276.0	3000	0.94	22.5				
2640M-08V30*	-08	1/2	0.97	15,000	60,000	9,200	0.900	4,350				
	12	12.7	24.7	103.5	414.0	2800	1.34	30.0				

\* these hoses have not been fully qualified yet. All values for these hoses are estimated ones.

**SeaWolf® high collapse resistance aramid reinforced hoses with nylon core tube and TPU outer jacket.**

Working temperature for these hoses is -40°C to +60°C (-40°F to +140°F)

Chemical resistance of core tube see PFDE-ES28

#						Max length		Collapse pressure
	size <i>DN</i>	inch <i>mm</i>	inch <i>mm</i>	psi <i>MPa</i>	psi <i>MPa</i>			
<b>57CRN-08V30</b>	-08	1/2	1.18	5,000	20,000	656	0.632	3,340
	12	12.7	30.0	34.5	138.0	200	0.94	23.0
<b>57CRN-16V02</b>	-16	1	2.01	5,000	20,000	656	1.458	3,340
	25	25.4	51.0	43.5	138.0	200	2.17	23.0

## Parker engineering manual

### recommended practices for handling, maintenance and inspection of long length Parker polyflex offshore hoses and hose assemblies

Parker Publication No. PFDE-ES28  
Revised: Oct 2006

#### 1 SCOPE

This engineering standard provides recommended practices for handling, maintenance and inspection of Parker Polyflex multispiral wire reinforced hoses and hose assemblies.

These hoses are being increasingly used subsea for applications such as annulus service lines, hot line and light well intervention in lengths of up to 3000m.

Deployed as single line hoses or used in bundles, the hoses are available in sizes range from 3/16" to 2" inside diameter. The hoses may be further protected by an additional sheath or incorporate a dual colour, extra thick ColorGard™ sheath.

Hose can be self supporting, clamped, or supported by a guide wire.

It is essential that the customer details the actual operating conditions of the hose to enable Parker to recommend the best hose construction for the application.

SAE J1273 is an excellent document providing general guidelines for selection, routing, fabrication, installation, replacement, maintenance, and storage of hose and hose assemblies for fluid power systems. SAE J1273, and Parkers experience in supplying products to the offshore industry provide the basis for the recommendations included in this engineering standard.

#### 2 HOSE FEATURES

Parker Polyflex multispiral wire reinforced hoses are suitable for use in the offshore environment. They are tough, offer excellent chemical, external collapse, ozone and microbiological resistance. In extreme conditions, additional protection can be added

by specifying the ColorGard™ extra thick sheath safety feature or an additional protective oversheath.

#### 3 STORAGE

Hoses and hose assemblies should be stored, wherever possible, protected from the elements in a stress free condition either straight, in a coil, or on a drum. The inside diameter of the coil or drum should not be less than two times the minimum bend radius. The fittings should be capped to prevent ingress of dirt or other contamination and any exposed threads protected from damage.

Storage of hoses and hose assemblies should take into account potential exposure to corrosive liquids, rodents, insects and high temperatures.

#### 4 HANDLING

Only trained personnel should handle and connect hose assemblies.

Incorrect handling will seriously reduce the lifetime of the hose and could cause dramatic failure. The use of wire rope or chains directly against the outer cover should be avoided, and the routing of the assembly should ensure the hose is never bent below its minimum bend radius. Special attention should be paid to the area at the back of the fitting.

When reeling long length hose onto a drum it is essential to minimise the tension on the hose. Proof testing of a "stretched" hose while on the drum can cause premature failure of the hose or damage to the drum.

When operating from a winch it is recommended that the hose is pressurised during the deployment and retrieving operation.

This significantly reduces the potential for deforming the hose during storage and is very important if it is planned to proof test the hose while on winch. Pressures up to 200 bar had been found satisfactory but this depends on the hose and local safety regulations. Pressures should not exceed the working pressure of the hose assembly.

When re-spooling, the pay-off and take-up drums should be inline and a minimum of 10m apart (see Fig.1). The hose should be spooled from the top of the pay-off drum onto the top of the take-up drum. This follows the natural set in the hose and minimises the possibility of inducing twist into the hose.

When re-spooling a new hose that has a polyurethane cover, it is recommended to lubricate the hose cover with soapy water or other suitable lubricant so the hose will traverse more easily and position itself correctly onto the take-up drum/winch.

Fig.1 Hose re-spooling

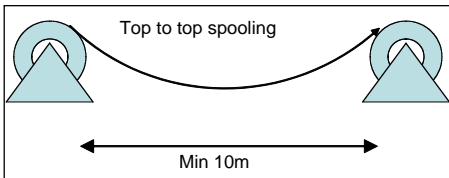

**5 POSSIBLE CAUSES OF PREMATURE FAILURE, AND SUGGESTED PREVENTATIVE MEASURES**

**5.1 Bending the hose below the minimum bend radius**

This is most likely to occur if the end fitting is not supported during lifting, a support sling wrongly positioned, or the hose being pulled round a tight corner.

Bend restrictors and containment grips are useful accessories that help to reduce this type of handling problem.

**5.2 Damage of the hose cover**

If the hose cover is damaged to the extent that the reinforcing wires are exposed, corrosion of the wires will occur causing a progressive reduction in burst pressure, and ultimately failure.

If used subsea, the damaged cover will allow water to ingress into the carcass of the hose and cause the core tube to collapse.

The ColorGard™ extra thick, dual colour cover option minimises the risk of exposing the reinforcing wires. If the outer cover is being abraded, the subsequent exposure of the red inner cover gives a visual early warning that a hose needs repairing or replacing.

**5.3 Kinked, crushed, twisted or flattened hose**

Any major distortion of the hose will also affect the function and alignment of the reinforcing wires. This will reduce the burst pressure and the external collapse pressure and could result in a sudden catastrophic failure of the hose.

**5.4 Chemical attack or ageing of the core tube**

The use of chemicals at differing concentrations and/or temperatures can have a major effect on the life of a hose and may cause dramatic hose failure.

**5.5 Damage or corrosion of the end fitting**

Incorrect handling or insufficient flushing after use could result in damage or corrosion of the end fitting. This will make connection difficult, probably cause leakage, and could result in sudden failure of the connection.

**5.6 Excessively high flow rates**

Depending on the abrasive properties of the fluid, high flow rates can result in erosion in the bore of the end fitting. Due to the resilience of the core tube material it is normally the fitting which gives the first indication of erosion, but the core tube could be damaged as well.

## 6 INSPECTION AND MAINTENANCE

- 6.1 A complete visual inspection of the hose assembly should be made prior to the start of any operation. Any of the following conditions shall require immediate removal of the hose assembly from service.
- Damage to the outer cover which exposes the reinforcing wires.
  - Kinked, crushed, flattened or twisted hose.
  - Blistered, soft, degraded, or loose outer cover.
  - Cracked, damaged, or badly corroded fittings.

If in doubt, a damaged hose assembly should be returned to the original supplier for inspection.

- 6.2 After completion of each job both inside and outside hose surfaces should be flushed with sufficient clean water to ensure that all chemicals or residues are fully removed from the hose assembly.

- 6.3 It is recommended that hose assemblies be returned to the original supplier at least once a year for inspection. The supplier will issue a report detailing the condition of the assembly, and recommend recertification, repair, or replacement.

National laws or conditions may require a different testing frequency.

## Chemical resistance for Nylon 11

Nylon 11 is the most common core tube material used for Parker Polyflex oil & gas hoses.  
Please refer to the hose data sheet.

### Ratings code

- \* – Swelling
- A – Good
- B – Limited
- X – Unsatisfactory

Chemical	Concentration	20°C (68°F)	40°C (104°F)	60°C (140°F)
Acetaldehyde		A	B	X
Acetic Acid	5%	A	A	A
Acetic Acid	10%	A	A	B
Acetic Acid	50%	B		
Acetic Anhydride		B	X	X
Acetone	Pure	A	A	A
Acetylene		A	A	A
Aluminium Sulfate	Sat Sol.	A	A	A
Ammonia	Liquid or Gas	A	A	A
Ammonium Chloride		A	A	A
Ammonium Hydroxide	Concentrated	A	A	A
Ammonium Nitrate		A	A	A
Ammonium Sulfate	Saturated Solution	A	A	B
Amyl Acetate		A	A	A
Aniline		B*	X	X
Barium Chloride	Saturated Solution	A	A	A
Benzaldehyde		A	B	X
Benzene		A	A*	B
Bezyl Alcohol		B	X	X
Butane		A	A	A
Butyl Alcohol		A*	B	X
Calcium Arsenate		A	A	A
Calcium Chloride	Saturated Solution	A	A	A
Calcium Nitrate		A		

**Chemical resistance for Nylon 11**

Chemical	Concentration	20°C (68°F)	40°C (104°F)	60°C (140°F)
Camphor		A		
Carbon Disulfide		A*	B*	X
Carbon Tetrachloride		B	X	
Cement Slurries		A	A	A
Chloroform		B	X	X
Citric Acid	Saturated Solution	A	A	B
Copper Sulfate		A	A	A
Cyclohexane		A	A	B
Cyclohexanol		A	B	X
Cyclohexanone		A	B	X
Diammonium Phosphate		A	A	B
Dichloroethylene		B	X	
Diesel		A	A	
Diethanolamine	20%	A	A*	A*
Diethyl Ether		A		
Dioctylphosphate		A	A	A
Dioctylphthalate		A	A	A
Ethanol	Pure	A*	B	X
Ethyl Acetate		A	A	A
Ethylene Glycol		A*	A*	B
Ethylene Oxide		A	A	B
Fatty Acid Esters		A	A	A
Formaldehyde	Technical	A	B	X
Formic Acid	9%	A	B	X
Furfuryl Alcohol		A	A*	B
Gas (Coal)		A	A	
Gasoline (High Octane)		A	A	A*
Glucose		A	A	A
Glycerine	Pure	A	A	B
Glycol		A	A	B
Heptane		A	A	A*
Hydrogen		A	A	A
Hydrogen Peroxide	20%	A	B	
Hydrochloric Acid	10%	A	A	X
Hydrochloric Acid	20%	A	X	X
Hydrofluoric Acid	3%	A	B	X

Technical Info

Chemical	Concentration	20°C (68°F)	40°C (104°F)	60°C (140°F)
Isocyanates		B		
Isopropyl Alcohol		A		
Kerosene		A	A	A*
Lactic Acid		A	A	A
Magnesium Chloride	50%	A	A	A
Mercury		A	A	A
Methane		A	A	A
Methanol	Pure	A	B	B*
Methyl-Cellosolve		A	A	A
Methyl Acetate		A	A	A
Methyl Bromide		A	X	
Methyl Chloride		A	B	
Methyl Sulfate		A	A	B
Methyl Ethyl Ketone		A	A	B
Methyl Isobutyl Ketone		B	X	X
Monochlorobenzene		A	A	A*
Naphta		A	A	A
Naphtalene		A	A	A
Oil Crude		A	A	A
Oils Refined		A	A	A
Oleic Acid		A	A	A
Oxalic Acid		A	A	B
Perchloroethylene		B	X	
Phosphoric Acid	40%	A	B	X
Picric Acid		B	X	X
Potassium Carbonate		A	A	B
Potassium Chloride		A	A	B
Potassium Hydroxide	50%	A	B	X
Potassium Nitrate		A*	B*	X
Potassium Sulfate		A	A	A
Propane		A	A	A
Pydraul F9		A	A	A
Pyridine	Pure	B	X	X
Sodium Carbonate	Saturated Solution	A	A	B
Sodium Chloride	Saturated Solution	A	A	A
Sodium Hydroxide	50%	A	B	X

**Chemical resistance for Nylon 11**

Chemical	Concentration	20°C (68°F)	40°C (104°F)	60°C (140°F)
Sodium Hypochlorite	Concentrated	B	X	X
Sodium Hypochlorite	Dilute Commercial Grade	A	B	X
Sodium Sulfide		A	B	B
Stearin		A	A	A
Stearic Acid		A	A	A
Styrene Monomer		A	A*	
Sulfic Anhydride		B	X	X
Tartaric Acid		A	A	A
Tetraethyl Lead		A		
Tetrahydrofurane		A	A	B
Toluene		A	A*	B
Trichloroethane		B	X	
Trichloroethylene		B	X	
Tricresyl Phosphate		A	A	A
Tributyl Phosphate		A	A	A
Trisodium Phosphate		A	A	A
Triphenyl Phosphate		A	A	B
Turpentine		A	A	A*
Urea		A	A	B
Uric Acid		A	A	A
Vinegar		A	A	A
Water		A	A	A
Water Sea		A	A	A
Water Soda		A	A	A
Xylene		A	A*	B
Zinc Chloride		A	A	B

Technical Info

## General chemical resistance table

### Ratings code

- G – Good to excellent. Little or no swelling, tensile or surface changes. Preferred choice.
- L – Marginal or conditional. Noticeable effects but not necessarily indicating lack of serviceability. Further testing suggested for specific application. Very long-term effects such as stiffening or potential for crazing should be evaluated.
- P – Poor or unsatisfactory. Not recommended without extensive and realistic testing.
- – Indicates that this was not tested.

### Materials code for hose core tubes

- N Polyamide
- M Coextruded tube with Fluoropolymer inner liner

### Materials code for hose cover

- N Polyamide
- U/HF Polyurethane

### Notes on the chemical resistance table

- (1) The fluid resistance tables are simplified rating tabulations based on immersion tests at 24° C. Higher temperatures tend to reduce ratings. Since final selection depends on pressure, fluid and ambient temperature and other factors not known to Parker Hannifin, no performance guarantee is expressed or implied. The indications do not imply any compliance with standards and regulations and do not refer to possible changes of colour, taste or smell. For food and drinking water specially approved materials have to be used. For fluids not listed or for advice on particular applications, please consult Parker Hannifin GmbH, **polyflex™** Division in Hüttefeld, Germany.
- (2) Hose applications for these fluids must take into account legal and insurance regulations. The chemical resistance indicated does not express or imply approval by certain institutions.
- (3) Satisfactory at some concentrations and temperatures, unsatisfactory at others.
- (4) For gas applications, the cover should be pin-pricked and the pressure must not be released quickly. Special safety guard accessories are to be used to prevent damage or personal injury in the event of failure..
- (5) Chemical resistance does not imply low permeation rates. Please consult Parker Hannifin for a recommendation for your specific requirements.
- (6) The indication of chemical resistance does not imply any special food compatibility; it refers only to the chemical resistance of the material.
- (7) Chemical resistance does not imply acceptability for use in airless paintspray applications. These applications require a special, electrically conductive hose.

Not all remarks may apply to Oil&Gas products

**General chemical resistance table**

<b>Chemical</b>	<b>N</b>	<b>U/HF</b>	<b>M</b>
Acetone	G	P	L
Acetylene	--	--	--
Air (4)	G	G	G
Ammonium Chloride	P	G	G
Ammonium Hydroxyde	G	P	G
Anhydrous Ammonia	P	P	--
Aniline	P	P	G
Aromatic Hydrocarbons	G	L	--
Asphalt	G	G	L
Benzene	G	L	G
Butane (2) (4)	G	L	--
Calcium Chloride	--	G	G
Carbon Dioxide (4)	G	G	--
Carbon Monoxide (4)	--	G	--
Carbon Tetrachloride	G	P	G
Chlorinated Hydrocarbon Base Fluids	G	L	--
Chlorinated Petroleum Oil	G	L	--
Chlorinated Solvents	--	P	--
Chlorine, Gaseous, Dry	P	P	--
Chromic Acid	--	P	L
Citric Acid Solutions	G	L	G
Crude Petroleum Oil	G	G	--
Cyclohexan (2)	G	G	G
Diesel Fuel (2)	G	G	--
Diester Oils	G	P	--
Ethanol (6)	G	L	--
Ethers	G	P	G
Ethylene Glycol	G	L	G
Ethylene Oxide	G	L	--
Fatty Acids	G	--	G
Formaldehyde	L	P	G
Formic Acid J	P	P	G
Fuel Oil (2)	G	L	G
Gas (Oil) (2)	G	G	
Gasoline	G	--	G
Glycerine	G	L	G
Glycols (to 1350 °F)	G	L	G

Technical Info

Chemical	N	U/HF	M
Grease (petroleum base)	G	G	--
Hexane (2)	G	G	G
Hydraulic Fluid (petroleum base)	G	G	L
Hydraulic Fluid phosphate ester base)	G	L	--
Hydraulic Fluid water base)	G	G	--
Hydraulic oil (petroleum base)	G	G	L
Hydrochloric Acid	L	P	G
Hydrofluoric Acid	P	P	G
Hydrolube (hydraulic fluid/water glycol base)	G	L	--
IRUS 902 (hydraulic fluid/water-oil emulsion)	G	G	--
Isooctane (2)	G	G	G
Kerosene (2)	G	L	G
Ketones	G	P	G
Lime (calcium oxide)	G	G	G
Lindol (hydraulic fluid/phosphate esters)	G	P	--
LP-Gas	--	--	--
Lubricating Oils (diester base)	G	P	--
Lubricating Oils (petroleum base)	G	G	G
Methane	--	--	--
Methanol	G	P	--
Methyl Alcohol (6)	G	P	G
Methyl Ethyl Ketone (MEK)	G	P	G
Methyl Ethyl Ketone Peroxide (MEKP)	L	P	--
Methyl Osobuthyl Ketone (MIBK)	G	P	G
Methylen Chloride	L	P	G
Mineral Oil	G	G	G
Mineral Spirits	--	L	--
Motor Oils	G	G	G
Naphta	G	P	G
Natural Gas (4)	--	--	--
Nitric Acid	P	P	L
Nitrobenzene	G	P	G
Nitrogen, Gaseous (4) (5)	G	G	G
Nitrous Oxide	L	--	--
Oil (SAE)	G	G	--
Oxygen, Gaseous (4) (5) (6)	G	G	G
Ozone	P	L	G

**General chemical resistance table**

<b>Chemical</b>	<b>N</b>	<b>U/HF</b>	<b>M</b>
Pentane (2)	G	L	G
Perchloric Acid	P	P	L
Petroleum Ether	--	--	--
Petroleum Oils	G	G	--
Phenols	P	P	--
Phosphate Esters (above 135 °F)	G	P	--
Phosphate Esters (to 135 °F)	G	P	--
Propane (4) (5)	--	--	--
Propylen Glycol	--	G	G
Salt Water	--	--	G
Silicone Greases	G	G	--
Silicone Oils	G	G	--
Sodium Borate	G	G	G
Sodium Carbonate	--	--	--
Sodium Chloride Solutions	G	G	G
Sodium Hydroxide, 50%	P	P	G
Sodium Hypochloride	P	P	G
Steam	P	P	G
Straight Synthetic Oils (phosphate esters)	G	P	--
Sulphur Dioxide	L	L	G
Sulphur Hexafluoride Gas (4) (5)	G	G	--
Sulphuric Acid	P	P	--
Toluol, Toluene	G	L	G
Trichlorethylene	L	P	G
Ucon (hydraulic fluid/water glycol base)	G	L	--
Water (above 60 °C) (6)	G	P	L
Water (to 60 °C) (6)	G	G	G
Water Glycols (above 60 °C)	L	P	--
Water Glycols (to 60 °C)	G	L	--
Water in oil Emulsions (above 60 °C)	L	P	--
Water in oil Emulsions (to 60 °C)	G	L	--
Xylene	G	P	G
Zinc Chloride	G	G	G

Technical Info

## Pressure drop tables for different hose sizes

### Remarks

Figures shown in the table are for 1 m of hose without fittings.  
 Figures derived from calculation, not from testing.  
 The recommended max fluid velocity is 7.6 m/s. Hoses have been used at higher fluid velocities. However this may result in cavitation. These flow figures are marked with a grey background.  
 Fluid: water  
 Dyn. viscosity: 1002 mPa s  
 Kin. viscosity: 1002 cSt  
 Temperature: 20 °C

### Flowrates 5 up to 80 l/min, sizes 5 mm (-03) up to 13 mm (-08)

Flowrate			nominal IDs				
[l/min]	Gal (UK)/min	Gal (US)/min	5 mm -03	6 mm -04	8 mm -05	10 mm -06	13 mm -08
5	1.1	1.3	0.5	0.2	0.1	0.02	0.01
10	2.2	2.6	1.7	0.7	0.2	0.06	0.02
15	3.3	4.0	3.6	1.5	0.4	0.1	0.03
20	4.4	5.3		2.4	0.6	0.2	0.06
25	5.5	6.6			0.9	0.3	0.09
30	6.6	7.9			1.3	0.4	0.12
35	7.7	9.2				0.6	0.16
40	8.8	10.6				0.7	0.2
45	9.9	11.9					0.25
50	11.0	13.2					0.3
60	13.2	15.9					0.4
70	15.4	18.5					0.6
80	17.6	21.1					0.7

### Flowrates 50 up to 3000 l/min, sizes 20 mm (-12) up to 50 mm (-32)

Flowrate			nominal IDs				
[l/min]	Gal (UK)/min	Gal (US)/min	20 mm -12	25 mm -16	32 mm -20	38 mm -24	50 mm -32
50	11	13	0.04	0	0	0	0
100	22	26	0.1	0.04	0	0	0
150	33	40	0.3	0.1	0	0	0
200	44	53	0.5	0.16	0	0	0
250	55	66	0.7	0.24	0	0	0
300	66	79		0.3	0.1	0	0
400	88	106			0.2	0	0
500	110	132			0.3	0.1	0
700	154	185			0.5	0.2	0.5
1000	220	264				0.4	0.1
1500	330	396					0.2
2000	440	528					0.4
3000	660	793					0.8

## Recommended tightening procedures

Connection	Thread sizes	Tightening torque	
		ft•lb	N•m
<b>High Pressure</b>			
1/4"	9/16" - 18thd	25	34
3/8"	3/4" - 16thd	50	69
9/16"	1-1/8" - 12thd	75	103
<b>Medium Pressure</b>			
1/4"	7/16" - 20thd	20	28
3/8"	9/16" - 18thd	30	41
9/16"	13/16" - 16thd	85	117
3/4"	3/4" NPSM	90	124
1"	1-3/8" - 12thd	125	173
<b>Type "M" Swivel</b>			
A9	9/16" - 18thd	25-30	34-41
A12	3/4" - 16thd	40-50	55-69
A14	7/8" - 14thd	50-60	69-83
A16	1" - 12thd	75-85	103-117
A21	1-5/16" - 12thd	100-120	138-166

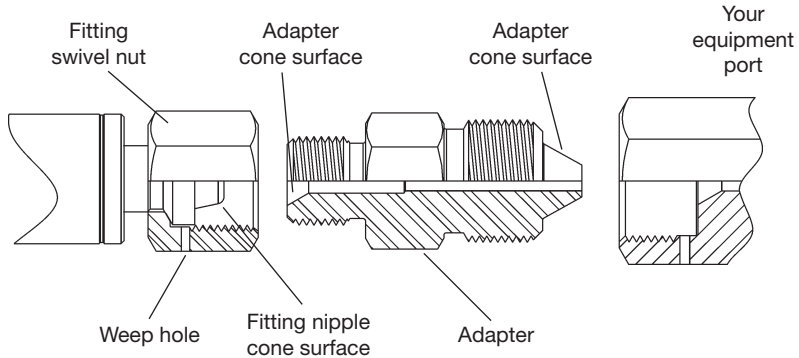

### Leakage at swivel nut-to-adapter Joint

(Seen by leak at weep hole in swivel nut)

1. Reduce system pressure to zero
2. Unscrew swivel nut and check cone surfaces of adapter and hose insert.
3. If hose insert is damaged, return hose to **polyflex** for repair and retest.
4. If cone surfaces look good after cleaning, re-tighten swivel nut. Do not exceed 150% of recommended torque.

### Leakage at type "M" adapter-to-port

(Seen by leak at weep hole in pressure port, or leak at threads for NPT adapters.)

1. Reduce system pressure to zero.
2. Slacken hose swivel nut.
3. Tighten adaptor into port.
4. Re-tighten swivel nut.

Never use the swivel nut to tighten the adapter into the port.

## Parker safety guide

### for selecting and using hose, tubing, fittings, and related accessories

Parker Publication No. 4400-B.1  
Revised: May 2002

**WARNING:** Failure or improper selection or improper use of hose, tubing, fittings, assemblies or related accessories ("Products") can cause death, personal injury and property damage. Possible consequences of failure or improper selection or improper use of these Products include but are not limited to:

- Fittings thrown off at high speed.
- High velocity fluid discharge.
- Explosion or burning of the conveyed fluid.
- Electrocutation from high voltage electric power lines.
- Contact with suddenly moving or falling objects that are controlled by the conveyed fluid.
- Injections by high-pressure fluid discharge.
- Dangerously whipping Hose.
- Contact with conveyed fluids that may be hot, cold, toxic or otherwise injurious.
- Sparking or explosion caused by static electricity buildup or other sources of electricity.
- Sparking or explosion while spraying paint or flammable liquids.
- Injuries resulting from inhalation, ingestion or exposure to fluids.

Before selecting or using any of these Products, it is important that you read and follow the instructions below. Only Hose from Parker's Stratoflex Products Division is approved for in flight aerospace applications, and no other Hose can be used for such in flight applications.

#### 1.0 GENERAL INSTRUCTIONS

- 1.1 Scope: This safety guide provides instructions for selecting and using (including assembling, installing, and maintaining) these Products. For convenience, all rubber and/or thermoplastic products commonly called "hose" or "tubing" are called "Hose" in this safety guide. All assemblies made with Hose are called "Hose Assemblies". All products commonly called "fittings" or "couplings" are called "Fittings". All related accessories (including crimping and swaging machines and tooling) are called "Related Accessories". This safety guide is a supplement to and is to be used with, the specific Parker publications for the specific Hose, Fittings and Related Accessories that are being considered for use.
- 1.2 Fail-Safe: Hose, and Hose Assemblies and Fittings can and do fail without warning for many reasons. Design all systems and equipment in a fail-safe mode, so that failure of the Hose or Hose Assembly or Fitting will not endanger persons or property.
- 1.3 Distribution: Provide a copy of this safety guide to each person that is responsible for selecting or using Hose and Fitting products. Do not select or use Parker Hose or Fittings without thoroughly reading and understanding this safety guide as well as the specific Parker publications for the products considered or selected.
- 1.4 User Responsibility: Due to the wide variety of operating conditions and applications for Hose and Fittings, Parker and its distributors do not represent or warrant that any particular Hose or Fitting is suitable for any specific end use system. This safety guide does not analyze all technical parameters that must be considered in selecting a product. The user, through its own analysis and testing, is solely responsible for:
- Making the final selection of the Hose and Fitting.
  - Assuring that the user's requirements are met and that the application presents no health or safety hazards.
  - Providing all appropriate health and safety warnings on the equipment on which the Hose and Fittings are used.
  - Assuring compliance with all applicable government and industry standards.

1.5 Additional Questions: Call the appropriate Parker technical service department if you have any questions or require any additional information. See the Parker publication for the product being considered or used, or call 1-800-CPARKER, or go to [www.parker.com](http://www.parker.com), for telephone numbers of the appropriate technical service department.

**2.0 HOSE AND FITTING SELECTION INSTRUCTIONS**

2.1 Electrical Conductivity: Certain applications require that the Hose be nonconductive to prevent electrical current flow. Other applications require the Hose and the Fitting and the Hose/Fitting interface to be sufficiently conductive to drain off static electricity. Extreme care must be exercised when selecting Hose and Fittings for these or any other applications in which electrical conductivity or nonconductivity is a factor.

The electrical conductivity or nonconductivity of Hose and Fittings is dependent upon many factors and may be susceptible to change. These factors include but are not limited to the various materials used to make the Hose and the Fittings, Fitting finish (some Fitting finishes are electrically conductive while others are nonconductive), manufacturing methods (including moisture control), how the Fittings contact the Hose, age and amount of deterioration or damage or other changes, moisture content of the Hose at any particular time, and other factors.

The following are considerations for electrically nonconductive and conductive Hose. For other applications consult the individual catalog pages and the appropriate industry or regulatory standards for proper selection.

2.1.1 Electrically Nonconductive Hose: Certain applications require that the Hose be nonconductive to prevent electrical current flow or to maintain electrical isolation. For these applications that require Hose to be electrically nonconductive, including but not limited to applications near high voltage electric lines, only special nonconductive Hose can be used. The manufacturer of the equipment in which the nonconductive Hose is to be used must be consulted to be

certain that the Hose and Fittings that are selected are proper for the application. Do not use any Parker Hose or Fitting for any such application requiring nonconductive Hose, including but not limited to applications near high voltage electric lines, unless (i) the application is expressly approved in the Parker technical publication for the product, (ii) the Hose is marked “nonconductive”, and (iii) the manufacturer of the equipment on which the Hose is to be used specifically approves the particular Parker Hose and Fitting for such use.

2.1.2 Electrically Conductive Hose: Parker manufactures special Hose for certain applications that require electrically conductive Hose. Parker manufactures special Hose for conveying paint in airless paint spraying applications. This Hose is labeled “Electrically Conductive Airless Paint Spray Hose” on its layline and packaging. This Hose must be properly connected to the appropriate Parker Fittings and properly grounded in order to dissipate dangerous static charge buildup, which occurs in all airless paint spraying applications. Do not use any other Hose for airless paint spraying, even if electrically conductive. Use of any other Hose or failure to properly connect the Hose can cause a fire or an explosion resulting in death, personal injury, and property damage. Parker manufactures a special Hose for certain compressed natural gas (“CNG”) applications where static electricity buildup may occur. Parker CNG Hose assemblies comply with AGA Requirements 1-93, “Hoses for Natural Gas Vehicles and Fuel Dispensers”. This Hose is labeled “Electrically Conductive for CNG Use” on its layline and packaging. This Hose must be properly connected to the appropriate Parker Fittings and properly grounded in order to dissipate dangerous static charge buildup, which occurs in, for example, high velocity CNG dispensing or transfer. Do not use any other Hose for CNG applications where static charge buildup may occur, even if electrically conductive. Use of other Hoses in CNG applications or failure to properly connect or ground this Hose can cause a fire or an explosion resulting in death, personal injury, and property damage. Care must also be taken to protect

against CNG permeation through the Hose wall. See section 2.6, Permeation, for more information. Parker CNG Hose is intended for dispenser and vehicle use at a maximum temperature of 180°F. Parker CNG Hose should not be used in confined spaces or unventilated areas or areas exceeding 180°F. Final assemblies must be tested for leaks. CNG Hose Assemblies should be tested on a monthly basis for conductivity per AGA 1-93.

Parker manufactures special Hose for aerospace in-flight applications. Aerospace in-flight applications employing Hose to transmit fuel, lubricating fluids and hydraulic fluids require a special Hose with a conductive inner tube. This Hose for in-flight applications is available only from Parker's Stratoflex Products Division. Do not use any other Parker Hose for in-flight applications, even if electrically conductive. Use of other Hoses for in-flight applications or failure to properly connect or ground this Hose can cause a fire or an explosion resulting in death, personal injury, and property damage. These Hose assemblies for in-flight applications must meet all applicable aerospace industry, aircraft engine, and aircraft requirements.

2.2 Pressure: Hose selection must be made so that the published maximum recommended working pressure of the Hose is equal to or greater than the maximum system pressure. Surge pressures or peak transient pressures in the system must be below the published maximum working pressure for the Hose. Surge pressures and peak pressures can usually only be determined by sensitive electrical instrumentation that measures and indicates pressures at millisecond intervals. Mechanical pressure gauges indicate only average pressures and cannot be used to determine surge pressures or peak transient pressures. Published burst pressure ratings for Hose is for manufacturing test purposes only and is no indication that the Product can be used in applications at the burst pressure or otherwise above the published maximum recommended working pressure.

2.3 Suction: Hoses used for suction applications must be selected to insure that the

Hose will withstand the vacuum and pressure of the system. Improperly selected Hose may collapse in suction application.

2.4 Temperature: Be certain that fluid and ambient temperatures, both steady and transient, do not exceed the limitations of the Hose. Temperatures below and above the recommended limit can degrade Hose to a point where a failure may occur and release fluid. Properly insulate and protect the Hose Assembly when routing near hot objects (e.g. manifolds). Do not use any Hose in any application where failure of the Hose could result in the conveyed fluids (or vapors or mist from the conveyed fluids) contacting any open flame, molten metal, or other potential fire ignition source that could cause burning or explosion of the conveyed fluids or vapors.

2.5 Fluid Compatibility: Hose Assembly selection must assure compatibility of the Hose tube, cover, reinforcement, and Fittings with the fluid media used. See the fluid compatibility chart in the Parker publication for the product being considered or used. This information is offered only as a guide. Actual service life can only be determined by the end user by testing under all extreme conditions and other analysis.

Hose that is chemically compatible with a particular fluid must be assembled using Fittings and adapters containing likewise compatible seals.

2.6 Permeation: Permeation (that is, seepage through the Hose) will occur from inside the Hose to outside when Hose is used with gases, liquid and gas fuels, and refrigerants (including but not limited to such materials as helium, diesel fuel, gasoline, natural gas, or LPG). This permeation may result in high concentrations of vapors which are potentially flammable, explosive, or toxic, and in loss of fluid. Dangerous explosions, fires, and other hazards can result when using the wrong Hose for such applications. The system designer must take into account the fact that this permeation will take place and must not use Hose if this permeation could be hazardous. The system designer must take into account all legal, government,

insurance, or any other special regulations which govern the use of fuels and refrigerants. Never use a Hose even though the fluid compatibility is acceptable without considering the potential hazardous effects that can result from permeation through the Hose Assembly.

Permeation of moisture from outside the Hose to inside the Hose will also occur in Hose assemblies, regardless of internal pressure. If this moisture permeation would have detrimental effects (particularly, but not limited to refrigeration and air conditioning systems), incorporation of sufficient drying capacity in the system or other appropriate system safeguards should be selected and used.

- 2.7 Size: Transmission of power by means of pressurized fluid varies with pressure and rate of flow. The size of the components must be adequate to keep pressure losses to a minimum and avoid damage due to heat generation or excessive fluid velocity.
- 2.8 Routing: Attention must be given to optimum routing to minimize inherent problems (kinking or flow restriction due to Hose collapse, twisting of the Hose, proximity to hot objects or heat sources).
- 2.9 Environment: Care must be taken to insure that the Hose and Fittings are either compatible with or protected from the environment (that is, surrounding conditions) to which they are exposed. Environmental conditions including but not limited to ultraviolet radiation, sunlight, heat, ozone, moisture, water, salt water, chemicals, and air pollutants can cause degradation and premature failure.
- 2.10 Mechanical Loads: External forces can significantly reduce Hose life or cause failure. Mechanical loads which must be considered include excessive flexing, twist, kinking, tensile or side loads, bend radius, and vibration. Use of swivel type Fittings or adapters may be required to insure no twist is put into the Hose. Unusual applications may require special testing prior to Hose selection.
- 2.11 Physical Damage: Care must be taken to protect Hose from wear, snagging, kinking, bending smaller than minimum bend radius, and cutting, any of which can cause premature Hose failure. Any Hose that has been kinked or bent to a radius smaller than the minimum bend radius, and any Hose that has been cut or is cracked or is otherwise damaged, should be removed and discarded.
- 2.12 Proper End Fitting: See instructions 3.2 through 3.5. These recommendations may be substantiated by testing to industry standards such as SAE J517 for hydraulic applications, or MIL-A-5070, AS1339, or AS3517 for Hoses from Parker's Stratoflex Products Division for aerospace applications.
- 2.13 Length: When establishing a proper Hose length, motion absorption, Hose length changes due to pressure, and Hose and machine tolerances and movement must be considered.
- 2.14 Specifications and Standards: When selecting Hose and Fittings, government, industry, and Parker specifications and recommendations must be reviewed and followed as applicable.
- 2.15 Hose Cleanliness: Hose components may vary in cleanliness levels. Care must be taken to insure that the Hose Assembly selected has an adequate level of cleanliness for the application.
- 2.16 Fire Resistant Fluids: Some fire resistant fluids that are to be conveyed by Hose require use of the same type of Hose as used with petroleum base fluids. Some such fluids require a special Hose, while a few fluids will not work with any Hose at all. See instructions 2.5 and 1.5. The wrong Hose may fail after a very short service. In addition, all liquids but pure water may burn fiercely under certain conditions, and even pure water leakage may be hazardous.
- 2.17 Radiant Heat: Hose can be heated to destruction without contact by such nearby items as hot manifolds or molten metal. The same heat source may then initiate a fire. This can occur despite the presence of cool air around the Hose.

- 2.18 **Welding or Brazing:** When using a torch or arc welder in close proximity to hydraulic lines, the hydraulic lines should be removed or shielded with appropriate fire resistant materials. Flame or weld spatter could burn through the Hose and possibly ignite escaping fluid resulting in a catastrophic failure. Heating of plated parts, including Hose Fittings and adapters, above 450°F (232°C) such as during welding, brazing, or soldering may emit deadly gases.
- 2.19 **Atomic Radiation:** Atomic radiation affects all materials used in Hose assemblies. Since the long-term effects may be unknown, do not expose Hose assemblies to atomic radiation.
- 2.20 **Aerospace Applications:** The only Hose and Fittings that may be used for in-flight aerospace applications are those available from Parker's Stratoflex Products Division. Do not use any other Hose or Fittings for in-flight applications. Do not use any Hose or Fittings from Parker's Stratoflex Products Division with any other Hose or Fittings, unless expressly approved in writing by the engineering manager or chief engineer of Stratoflex Products Division and verified by the user's own testing and inspection to aerospace industry standards.
- 2.21 **Unlocking Couplings:** Ball locking couplings or other couplings with disconnect sleeves can unintentionally disconnect if they are dragged over obstructions or if the sleeve is bumped or moved enough to cause disconnect. Threaded couplings should be considered where there is a potential for accidental uncoupling.
- 3.0 HOSE AND FITTING ASSEMBLY AND INSTALLATION INSTRUCTIONS**
- 3.1 **Component Inspection:** Prior to assembly, a careful examination of the Hose and Fittings must be performed. All components must be checked for correct style, size, catalog number, and length. The Hose must be examined for cleanliness, obstructions, blisters, cover looseness, kinks, cracks, cuts or any other visible defects. Inspect the Fitting and sealing surfaces for burrs, nicks, corrosion or other imperfections. Do NOT use any component that displays any signs of nonconformance.
- 3.2 **Hose and Fitting Assembly:** Do not assemble a Parker Fitting on a Parker Hose that is not specifically listed by Parker for that Fitting, unless authorized in writing by the engineering manager or chief engineer of the appropriate Parker division. Do not assemble a Parker Fitting on another manufacturer's Hose or a Parker Hose on another manufacturer's Fitting unless (i) the engineering manager or chief engineer of the appropriate Parker division approves the Assembly in writing or that combination is expressly approved in the appropriate Parker literature for the specific Parker product, and (ii) the user verifies the Assembly and the application through analysis and testing. For Parker Hose that does not specify a Parker Fitting, the user is solely responsible for the selection of the proper Fitting and Hose Assembly procedures. See instruction 1.4. The Parker published instructions must be followed for assembling the Fittings on the Hose. These instructions are provided in the Parker Fitting catalog for the specific Parker Fitting being used, or by calling 1-800-CPARKER, or at [www.parker.com](http://www.parker.com).
- 3.3 **Related Accessories:** Do not crimp or swage any Parker Hose or Fitting with anything but the listed swage or crimp machine and dies in accordance with Parker published instructions. Do not crimp or swage another manufacturer's Fitting with a Parker crimp or swage die unless authorized in writing by the engineering manager or chief engineer of the appropriate Parker division.
- 3.4 **Parts:** Do not use any Parker Fitting part (including but not limited to socket, shell, nipple, or insert) except with the correct Parker mating parts, in accordance with Parker published instructions, unless authorized in writing by the engineering manager or chief engineer of the appropriate Parker division.
- 3.5 **Reusable/Permanent:** Do not reuse any field attachable (reusable) Hose Fitting that has blown or pulled off a Hose. Do not reuse a Parker permanent Hose Fitting (crimped or

swaged) or any part thereof. Complete Hose Assemblies may only be reused after proper inspection under section 4.0. Do not assemble Fittings to any previously used hydraulic Hose that was in service, for use in a fluid power application.

- 3.6 Pre-Installation Inspection: Prior to installation, a careful examination of the Hose Assembly must be performed. Inspect the Hose Assembly for any damage or defects. Do NOT use any Hose Assembly that displays any signs of nonconformance.
- 3.7 Minimum Bend Radius: Installation of a Hose at less than the minimum listed bend radius may significantly reduce the Hose life. Particular attention must be given to preclude sharp bending at the Hose to Fitting juncture. Any bending during installation at less than the minimum bend radius must be avoided. If any Hose is kinked during installation, the Hose must be discarded.
- 3.8 Twist Angle and Orientation: Hose Assembly installation must be such that relative motion of machine components does not produce twisting.
- 3.9 Securement: In many applications, it may be necessary to restrain, protect, or guide the Hose to protect it from damage by unnecessary flexing, pressure surges, and contact with other mechanical components. Care must be taken to insure such restraints do not introduce additional stress or wear points.
- 3.10 Proper Connection of Ports: Proper physical installation of the Hose Assembly requires a correctly installed port connection insuring that no twist or torque is transferred to the Hose when the Fittings are being tightened or otherwise during use.
- 3.11 External Damage: Proper installation is not complete without insuring that tensile loads, side loads, kinking, flattening, potential abrasion, thread damage, or damage to sealing surfaces are corrected or eliminated. See instruction 2.10.
- 3.12 System Checkout: All air entrapment must be eliminated and the system pressurized to

the maximum system pressure (at or below the Hose maximum working pressure) and checked for proper function and freedom from leaks. Personnel must stay out of potential hazardous areas while testing and using.

- 3.13 Routing: The Hose Assembly should be routed in such a manner so if a failure does occur, the escaping media will not cause personal injury or property damage. In addition, if fluid media comes in contact with hot surfaces, open flame, or sparks, a fire or explosion may occur. See section 2.4.

#### **4.0 HOSE AND FITTING MAINTENANCE AND REPLACEMENT INSTRUCTIONS**

- 4.1 Even with proper selection and installation, Hose life may be significantly reduced without a continuing maintenance program. The severity of the application, risk potential from a possible Hose failure, and experience with any Hose failures in the application or in similar applications should determine the frequency of the inspection and the replacement for the Products so that Products are replaced before any failure occurs. A maintenance program must be established and followed by the user and, at minimum, must include instructions 4.2 through 4.7.
- 4.2 Visual Inspection Hose/Fitting: Any of the following conditions require immediate shut down and replacement of the Hose Assembly:
- Fitting slippage on Hose;
  - Damaged, cracked, cut or abraded cover (any reinforcement exposed);
  - Hard, stiff, heat cracked, or charred Hose;
  - Cracked, damaged, or badly corroded Fittings;
  - Leaks at Fitting or in Hose;
  - Kinked, crushed, flattened or twisted Hose; and
  - Blistered, soft, degraded, or loose cover.
- 4.3 Visual Inspection All Other: The following items must be tightened, repaired, corrected or replaced as required:
- Leaking port conditions;
  - Excess dirt buildup;
  - Worn clamps, guards or shields; and
  - System fluid level, fluid type, and any air entrapment.

- 4.4 **Functional Test:** Operate the system at maximum operating pressure and check for possible malfunctions and leaks. Personnel must avoid potential hazardous areas while testing and using the system. See section 2.2.
- 4.5 **Replacement Intervals:** Hose assemblies and elastomeric seals used on Hose Fittings and adapters will eventually age, harden, wear and deteriorate under thermal cycling and compression set. Hose Assemblies and elastomeric seals should be inspected and replaced at specific replacement intervals, based on previous service life, government or industry recommendations, or when failures could result in unacceptable downtime, damage, or injury risk. See section 1.2.
- 4.6 **Hose Inspection and Failure:** Hydraulic power is accomplished by utilizing high-pressure fluids to transfer energy and do work. Hoses, Fittings, and Hose Assemblies all contribute to this by transmitting fluids at high pressures. Fluids under pressure can be dangerous and potentially lethal and, therefore, extreme caution must be exercised when working with fluids under pressure and handling the Hoses transporting the fluids. From time to time, Hose Assemblies will fail if they are not replaced at proper time intervals. Usually these failures are the result of some form of misapplication, abuse, wear, or failure to perform proper maintenance. When Hoses fail, generally the high-pressure fluids inside escape in a stream which may or may not be visible to the user. Under no circumstances should the user attempt to locate the leak by “feeling” with their hands or any other part of their body. High-pressure fluids can and will penetrate the skin and cause severe tissue damage and possibly loss of limb. Even seemingly minor hydraulic fluid injection injuries must be treated immediately by a physician with knowledge of the tissue damaging properties of hydraulic fluid. If a hose failure occurs, immediately shut down the equipment and leave the area until pressure has been completely released from the Hose Assembly. Simply shutting down the hydraulic pump may or may not eliminate the pressure in the Hose Assembly. Many times check valves, etc., are employed in a system and can cause pressure to remain in a Hose Assembly even when pumps or equipment are not operating. Tiny holes in the Hose, commonly known as pinholes, can eject small, dangerously powerful but hard to see streams of hydraulic fluid. It may take several minutes or even hours for the pressure to be relieved so that the Hose Assembly may be examined safely. Once the pressure has been reduced to zero, the Hose Assembly may be taken off the equipment and examined. It must always be replaced if a failure has occurred. Never attempt to patch or repair a Hose Assembly that has failed. Consult the nearest Parker distributor or the appropriate Parker division for Hose Assembly replacement information. Never touch or examine a failed Hose Assembly unless it is obvious that the Hose no longer contains fluid under pressure. The high-pressure fluid is extremely dangerous and can cause serious and potentially fatal injury.
- 4.7 **Elastomeric seals:** Elastomeric seals will eventually age, harden, wear and deteriorate under thermal cycling and compression set. Elastomeric seals should be inspected and replaced.
- 4.8 **Refrigerant gases:** Special care should be taken when working with refrigeration systems. Sudden escape of refrigerant gases can cause blindness if the escaping gases contact the eye and can cause freezing or other severe injuries if it contacts any other portion of the body.
- 4.9 **Compressed natural gas (CNG):** Parker CNG Hose Assemblies should be tested after installation and before use, and at least on a monthly basis per AGA 1-93 Section 4.2 “Visual Inspection Hose/Fitting”. The recommended procedure is to pressurize the Hose and check for leaks and to visually inspect the Hose for damage. Caution: Matches, candles, open flame or other sources of ignition shall not be used for Hose inspection. Leak check solutions should be rinsed off after use.

## Glossary

### Abrasion

Abrasion occurs in numerous forms; two of the more common are the typical rubbing or chafing, with the second being very high frequency, low amplitude friction. This type of abrasion results from pump pressure pulses otherwise known as pump ripple. It can also be caused by equipment vibration or resonance. Abrasion may occur when two hose lines cross or when a hose line rubs or bears against a fixed point. Abrasion resistance is also a function of temperature and attack of the cover material by aggressive chemicals. Spring guards or other protective sleeving can also ward off premature hose failure resulting from abrasion. Spring guards also distribute bending force often associated with excessive side loading or even kinking at the skirt of the coupling.

### Ambient temperature

Exceedingly high or low ambient temperatures will affect the materials from which the hose is constructed and will negatively influence hose life. When at all possible, the hose should be routed in such a manner as to protect it from heat sources. In extreme cold applications, the equipment should be designed with remote relief valves to allow circulation and warming of the oil before hose articulation is attempted. The hose liner (core tube) of choice for extremely high or low temperature is Teflon®. Teflon® is serviceable at temperatures as low as -100°F and as high as +450°. Consult the specific hose operating parameters for more information.

### Bend radius

The minimum bend radii listed in this catalog are valid at rated working pressures and indicated service temperatures. Service life of a hose may be shortened if the minimum radius is exceeded or if the hose is flexed continuously in use.

#### Burst pressure and working pressure

The specified burst pressure for each hose style and dash size are for unaged hoses tested at normal laboratory temperature in accordance with SAE J343 specification for normal service and technically ideal installations. The maximum recommended working pressure is 1/4 of the mini-

mum rated burst pressure, except as otherwise specifically stated in those product specifications. For more severe service, a higher rated working pressure hose may have to be selected.

### Hose installation tips

Establish hose size (I. D.) and style based upon flow rate (GPM), pressure drop, and chemical compatibility with fluid medium. Other significant factors to be considered in hose selection and installation are discussed briefly as follows:

#### Operating temperature

The temperature range for satisfactory service (maximum hose life) depends to a great extent upon the fluid being conveyed. Use of a hose above maximum specified temperature ratings will shorten hose life due, but not limited, to oxidation, chemical degradation and loss of compression within the coupling.

#### Pressure effects

Pressure surges and system shocks (spikes) are common in hydraulic systems. The normal 4:1 safety factor should reflect these transient pressures. Where these surges and shocks are considered severe or hazardous, the safety factor should be increased.

When hose is under pressure, it may change in length by as much as ±3%. Installation should compensate for shortening by providing an appropriate amount of slack and for lengthening by allowing space for this growth to be absorbed.

#### Routing and clamping

Whenever possible, and maximum efforts should be made to do so, hose should be routed to flex in a single plane. Routing hoses in flexure through compound bends results in torsions. When this is unavoidable, the torsion should be distributed over the maximum hose length possible. Wire reinforced hoses suffer the most rapid and severe loss of service life when applied in torsion. Extremely tight and improperly located clamps focus this torsion over short distances.

Analysis of the hose function is required before

the proper clamping techniques can be selected. In some applications, hoses must be contained to stay out of harm's way and at the same time be free to come and go with equipment articulation. Other applications may require restrictive clamping, in which case a protective material should be used around the hose to provide the grasp without deformation of the hose by the clamp. These techniques also apply to the use of the popular method of clamping and clustering hoses with plastic tie straps.

Parker swivel adaptors feature 360° swiveling action that especially suits them for use in applications where hose moves, bends or twists. Swivel adapters connected to hose assemblies relieve twisting, prevent excessive flexing of hose, eliminate need for long radius bends, and cushion intraline shock caused by peak system pressure pulses.

### High pressure adapters

It is critical that the adapter material be properly suited to the fluid media. Widely varying conditions frequently necessitate high pressure adapters constructed of materials other than conventional 316 stainless steel. Since many variables affect the corrosion resistance of metallic materials, it is Parker Hannifin's policy not to recommend materials based on corrosion resistance for specific fluid applications. The published recommended working pressure represent the capability of the subject fitting. Nevertheless, in some instances, the hose, hose fitting or other connector assembled to the adapter may dictate the maximum working pressure. The end-user should read and understand the Parker Safety Guide (Bulletin 4400-B.1) and follow its suggested practices and warnings.



**Chapter K****Index of part numbers**

Index .....	K-2
-------------	-----

## Index of part numbers

<b>Part number</b>	<b>page</b>	<b>Part number</b>	<b>page</b>
1AY8X-6-04C	B-27	02Y5-8-6C	G-18
1AYUX-6-04C	B-44	02Y5-8-8C	G-18
1AYUX-8-05C	B-44	02Y5-8-12C	G-18
1AYUX-8-06C	B-44	02Y5-8-16C	G-18
1C9LX-10-04C	B-24, B-42, D-15	02Y5-12-4C	G-19
1C9LX-14-06C	B-24, D-15	02Y5-12-6C	G-19
1C9LX-14-06C-M-Subsea	B-42	02Y5-12-9C	G-19
1C9LX-16-08C	B-24, D-15	02Y5-12-12C	G-19
1C9LX-16-08C-M-Subsea	B-42	02Y5-12-16C	G-19
1C9LX-25-12C	B-24	02Y5-16-6C	G-19
1C9LX-30-16C	B-24	02Y5-16-9C	G-19
1C9NX-8-04-OF	B-7	02Y5-16-12C	G-19
1C9NX-10-04-OF	B-7	02Y5-16-16C	G-19
1C9NX-12-06-OF	B-7	02Y6-2-4C	G-35
1C9NX-38-20C	B-18	02Y6-2-6C	G-35
1C9RX-8-04C	B-12, B-33	02Y6-2-9C	G-35
1C9RX-10-04C	B-12, B-33	02Y6-4-4C	G-35
1C9RX-12-06C	B-15, B-36	02Y6-4-6C	G-35
1C98X-8-04C	B-18	02Y6-4-9C	G-35
1C98X-10-04C	B-18	02Y6-6-4C	G-35
1C98X-12-06C	B-18	02Y6-6-6C	G-35
1C98X-16-08C	B-18	02Y6-6-9C	G-35
1C99X-12-06C	B-21	02Y6-8-4C	G-35
1C99X-16-08C	B-15, B-21, C-6	02Y6-8-6C	G-35
1C99X-25-12C	B-21, C-6	02Y6-8-9C	G-35
1C99X-30-16C	B-21, C-6	02Y6-12-6C	G-35
1C955-10-4C	B-4, D-6	02Y6-12-9C	G-35
1C955-12-6C	B-4, D-6	02Y6-16-9C	G-35
1C955-16-8C	B-4, D-6	5Y01-4-2C	G-16
1Y2LX-6-04M-INC625	B-40	5Y01-4-4C	G-16
1Y2UX-6-04C	B-44	5Y01-4-6C	G-16
1Y2UX-6-05C	B-44	5Y01-4-8C	G-16
1Y2UX-9-06C	B-44	5Y01-4-12C	G-16
1Y28X-6-04C	B-27	5Y01-4-16C	G-16
2TURX-4-2C	D-3	5Y01-6-2C	G-16
02Y5-2-4C	G-18	5Y01-6-4C	G-16
02Y5-2-6C	G-18	5Y01-6-6C	G-16
02Y5-2-9C	G-18	5Y01-6-8C	G-16
02Y5-2-12C	G-18	5Y01-6-12C	G-16
02Y5-2-16C	G-18	5Y01-6-16C	G-16
02Y5-4-4C	G-18	5Y01-9-2C	G-16
02Y5-4-6C	G-18	5Y01-9-4C	G-16
02Y5-4-9C	G-18	5Y01-9-6C	G-16
02Y5-4-12C	G-18	5Y01-9-8C	G-16
02Y5-4-16C	G-18	5Y01-9-12C	G-16
02Y5-6-4C	G-18	5Y01-9-16C	G-16
02Y5-6-6C	G-18	5Y01-12-2C	G-17
02Y5-6-9C	G-18	5Y01-12-4C	G-17
02Y5-6-12C	G-18	5Y01-12-6C	G-17
02Y5-6-16C	G-18	5Y01-12-8C	G-17
02Y5-8-4C	G-18	5Y01-12-12C	G-17

Part number	page	Part number	page
5Y01-12-16C.....	G-17	5Y5Y-16-16C.....	G-20
5Y01-16-2C.....	G-17	5Y6Y-4-4C.....	G-22
5Y01-16-4C.....	G-17	5Y6Y-4-6C.....	G-22
5Y01-16-6C.....	G-17	5Y6Y-4-9C.....	G-22
5Y01-16-8C.....	G-17	5Y6Y-6-4C.....	G-22
5Y01-16-12C.....	G-17	5Y6Y-6-6C.....	G-22
5Y01-16-16C.....	G-17	5Y6Y-6-9C.....	G-22
5Y02-4-2C.....	G-23	5Y6Y-9-4C.....	G-22
5Y02-4-4C.....	G-23	5Y6Y-9-6C.....	G-22
5Y02-4-6C.....	G-23	5Y6Y-9-9C.....	G-22
5Y02-4-8C.....	G-23	5Y6Y-12-4C.....	G-22
5Y02-4-12C.....	G-23	5Y6Y-12-6C.....	G-22
5Y02-4-16C.....	G-23	5Y6Y-12-9C.....	G-22
5Y02-6-2C.....	G-23	5Y6Y-16-4C.....	G-22
5Y02-6-4C.....	G-23	5Y6Y-16-6C.....	G-22
5Y02-6-6C.....	G-23	5Y6Y-16-9C.....	G-22
5Y02-6-8C.....	G-23	5Y5-4-6C.....	G-13
5Y02-6-12C.....	G-23	5Y5-4-9C.....	G-13
5Y02-6-16C.....	G-23	5Y5-4-12C.....	G-13
5Y02-9-2C.....	G-23	5Y5-4-16C.....	G-13
5Y02-9-4C.....	G-23	5Y5-6-4C.....	G-13
5Y02-9-6C.....	G-23	5Y5-6-9C.....	G-13
5Y02-9-8C.....	G-23	5Y5-6-12C.....	G-13
5Y02-9-12C.....	G-23	5Y5-6-16C.....	G-13
5Y02-9-16C.....	G-23	5Y5-9-4C.....	G-13
5Y02-12-2C.....	G-24	5Y5-9-6C.....	G-13
5Y02-12-4C.....	G-24	5Y5-9-12C.....	G-13
5Y02-12-6C.....	G-24	5Y5-9-16C.....	G-13
5Y02-12-8C.....	G-24	5Y5-12-4C.....	G-13
5Y02-12-12C.....	G-24	5Y5-12-6C.....	G-13
5Y02-12-16C.....	G-24	5Y5-12-9C.....	G-13
5Y02-16-2C.....	G-24	5Y5-12-16C.....	G-13
5Y02-16-4C.....	G-24	5Y5-16-4C.....	G-13
5Y02-16-6C.....	G-24	5Y5-16-6C.....	G-13
5Y02-16-8C.....	G-24	5Y5-16-9C.....	G-13
5Y02-16-12C.....	G-24	5Y5-16-12C.....	G-13
5Y02-16-16C.....	G-24	5Y6-4-4C.....	G-14
5Y5Y-4-4C.....	G-20	5Y6-4-6C.....	G-14
5Y5Y-4-6C.....	G-21	5Y6-4-9C.....	G-14
5Y5Y-4-9C.....	G-21	5Y6-6-4C.....	G-14
5Y5Y-4-12C.....	G-21	5Y6-6-6C.....	G-14
5Y5Y-4-16C.....	G-21	5Y6-6-9C.....	G-14
5Y5Y-6-6C.....	G-20	5Y6-9-4C.....	G-14
5Y5Y-6-9C.....	G-21	5Y6-9-6C.....	G-14
5Y5Y-6-12C.....	G-21	5Y6-9-9C.....	G-14
5Y5Y-6-16C.....	G-21	5Y6-12-4C.....	G-14
5Y5Y-9-9C.....	G-20	5Y6-12-6C.....	G-14
5Y5Y-9-12C.....	G-21	5Y6-12-9C.....	G-14
5Y5Y-9-16C.....	G-21	5Y6-16-4C.....	G-14
5Y5Y-12-12C.....	G-20	5Y6-16-6C.....	G-14
5Y5Y-12-16C.....	G-21	5Y6-16-9C.....	G-14

**Index**

<b>Part number</b>	<b>page</b>
6AY5X-11-8C	B-29
6AY5X-16-12C	B-29
6AY5X-16-12C-SD	B-29
6AY5X-16-16C	B-29
6AY5X-16-16C-SD	B-29
6AY5X-16-16C-TC	E-6
6AY9X-8-6C	B-21
6AY9X-11-8C	B-21
6AY9X-16-12C	B-21
6AY9X-16-16C	B-21
6AYLX-6-4C	B-18, E-6
6AYLX-6-4C-M-Subsea	B-38
6AYLX-6-4C-SD	B-18
6AYLX-8-5C	D-12
6AYLX-8-6C	B-25
6AYLX-11-8C	B-25
6AYLX-11-8C-SD	B-25
6AYLX-16-12C	B-25
6AYLX-16-12C-SD	B-25
6AYLX-16-16C	B-25
6AYLX-16-16C-SD	B-25
6AYLX-16-16C-TC	E-3
6C9LX-8-4C-M-Subsea	B-39
6C9LX-10-4C-M-Subsea	B-39
6C9LX-25-12C	D-15
6C9LX-30-16C	D-15
6C9LX-30-16C-TC	E-3
6C95X-16-08C	B-30
6C95X-25-12C	B-30
6C95X-30-16C	B-30
6C95X-30-16C-TC	E-6
6HE5X-32-24-TC	E-4
6HE5X-32-32-TC	E-4
6HN5X-32-24-TC	E-4
6HN5X-32-32-TC	E-4
6Y01-4-2C	G-34
6Y01-4-4C	G-34
6Y01-4-6C	G-34
6Y01-4-8C	G-34
6Y01-4-12C	G-34
6Y01-4-16C	G-34
6Y01-6-2C	G-34
6Y01-6-4C	G-34
6Y01-6-6C	G-34
6Y01-6-8C	G-34
6Y01-6-12C	G-34
6Y01-6-16C	G-34
6Y01-9-2C	G-34
6Y01-9-4C	G-34
6Y01-9-6C	G-34
6Y01-9-8C	G-34

<b>Part number</b>	<b>page</b>
6Y01-9-12C	G-34
6Y01-9-16C	G-34
6Y02-4-2C	G-39
6Y02-4-4C	G-39
6Y02-4-6C	G-39
6Y02-4-8C	G-39
6Y02-4-12C	G-39
6Y02-4-16C	G-39
6Y02-6-2C	G-39
6Y02-6-4C	G-39
6Y02-6-6C	G-39
6Y02-6-8C	G-39
6Y02-6-12C	G-39
6Y02-6-16C	G-39
6Y02-9-2C	G-39
6Y02-9-4C	G-39
6Y02-9-6C	G-39
6Y02-9-8C	G-39
6Y02-9-12C	G-39
6Y02-9-16C	G-39
6Y2LX-6-4C-M-Subsea	B-40
6Y6Y-4-4C	G-38
6Y6Y-4-6C	G-38
6Y6Y-4-9C	G-38
6Y6Y-6-6C	G-38
6Y6Y-6-9C	G-38
6Y6Y-9-9C	G-38
6Y25X-9-8C	B-29
6Y25X-12-8C	B-29
6Y25X-16-12C	B-29
6YY5-4-4C	G-15
6YY5-4-6C	G-15
6YY5-4-9C	G-15
6YY5-4-12C	G-15
6YY5-4-16C	G-15
6YY5-6-4C	G-15
6YY5-6-6C	G-15
6YY5-6-9C	G-15
6YY5-6-12C	G-15
6YY5-6-16C	G-15
6YY5-9-4C	G-15
6YY5-9-6C	G-15
6YY5-9-9C	G-15
6YY5-9-12C	G-15
6YY5-9-16C	G-15
6YY6-4-6C	G-33
6YY6-4-9C	G-33
6YY6-6-4C	G-33
6YY6-6-9C	G-33
6YY6-9-4C	G-33
6YY6-9-9C	G-33

Index of part nos

<b>Part number</b>	<b>page</b>	<b>Part number</b>	<b>page</b>
10K0101-12-12C.....	G-46	82C-R02-PFD.....	I-4
10K0101-16-16C.....	G-46	83C-9X04.....	I-3
10K0202-12-12C.....	G-44	83C-9X08.....	I-3
10K0202-16-16C.....	G-44	83C-9X16.....	I-3
10KL02-12C.....	G-44	83C-081-PFD.....	I-4
10KL02-16C.....	G-44	83C-F16G.....	I-3
10KT02-12C.....	G-45	83C-F16W.....	I-3
10KT02-16C.....	G-45	94C-080-PFD.....	I-4
10KX02-12C.....	G-45	101HP-2-3.....	D-8
10KX02-16C.....	G-45	101HP-2-4.....	D-8
15K0101-1-1C.....	G-46	101HP-4-3.....	D-8
15K0101-2-2C.....	G-46	101HP-4-4.....	D-8
15K0101-4-4C.....	G-46	101HP-4-6.....	D-8
15K0101-6-6C.....	G-46	101HP-6-3.....	D-8
15K0101-8-8C.....	G-46	101HP-6-4.....	D-8
15K0201-1-8C.....	G-46	101HP-6.6.....	D-8
15K0201-2-8C.....	G-46	101HP-8-6.....	D-8
15K0201-4-8C.....	G-46	106LH-4-3C.....	C-3
15K0201-6-8C.....	G-46	106LV-4-3C.....	C-3
15K0202-2-2C.....	G-44	106LV-12-12C.....	C-8
15K0202-4-4C.....	G-44	106LV-16-16C.....	C-8
15K0202-6-6C.....	G-44	106LX-6-04C.....	B-23
15K0202-8-8C.....	G-44	106LX-6-06C.....	B-23
15KL02-4C.....	G-44	106LX-6-06C-M-Subsea.....	B-42
15KL02-6C.....	G-44	106LX-8-06C.....	B-23
15KL02-8C.....	G-44	106LX-8-06C-M-Subsea.....	B-42
15KT02-4C.....	G-45	106LX-8-08C.....	B-23
15KT02-6C.....	G-45	106LX-8-08C-M-Subsea.....	B-42
15KT02-8C.....	G-45	106LX-10-08C.....	B-23
15KX02-4C.....	G-45	106LX-16-12C.....	B-23
15KX02-6C.....	G-45	106LX-16-16C.....	B-23
15KX02-8C.....	G-45	106LX-16-16C.....	B-23
57CR-08V02.....	B-8	106NX-4-04-OF.....	B-6
57CR-08V06.....	B-8	106NX-6-04-OF.....	B-6
57CR-16V02.....	B-8	106NX-8-06-OF.....	B-6
57CR-16V06.....	B-8	106NX-20-20C.....	B-17
57CRN-08V30.....	J-5	106RX-4-04C.....	B-11
57CRN-16V02.....	J-5	106RX-6-04C.....	B-11
80C-F04G.....	I-3	106RX-6-06C.....	B-35
80C-F06G.....	I-3	192NX-4-04-OF.....	B-6
80C-F08G.....	I-3	192NX-6-06-OF.....	B-6
80C-F08W.....	I-3	192NX-24-20C.....	B-17
80C-F10G.....	I-3	192RX-4-04C.....	B-11
80C-F12G.....	I-3	192RX-6-06C.....	B-14
80C-G03.....	I-3	201RX-2-2C.....	D-3
80C-G04.....	I-3	206RX-4-2C.....	D-3
80C-G06.....	I-3	520N-3.....	D-4
80C-HP3.....	I-3	520N-4.....	D-4
80C-HP4.....	I-3	520N-5.....	D-4
80C-HP6.....	I-3	520N-6.....	D-4
82C-R01-PFD.....	I-4	520N-8.....	D-4
		573LH-3.....	C-2

**Index**

<b>Part number</b>	<b>page</b>
575LH-3	C-2
575X-4	B-2
575X-6	B-2
575X-8	B-2
575X-12	B-2
575X-16	B-2
593-12	C-7
593-16	C-7
606CR-8-8C	B-9
606CR-16-16C	B-9
606LX-6-04C-M-Subsea	B-38
606LX-16-12C	D-14
606LX-16-16C	D-14
692LX-4-4C-M-Subsea	B-39
1018X-4-04C	D-11
1018X-6-05C	D-11
1018X-6-06C	D-11
1018X-8-08C	D-11
1068X-4-04C	B-17
1068X-6-04C	B-17
1068X-6-05C	D-11
1068X-8-06C	B-17
1068X-10-08C	B-17
1069X-8-06C	B-20
1069X-8-08C	B-14
1069X-12-12C	B-20
1069X-16-16C	C-5
1928X-4-04C	B-17
1928X-6-06C	B-17
1928X-8-08C	B-17
1929X-6-06C	B-20
1929X-8-08C	B-14
1929X-12-12C	B-20
1929X-16-16C	B-20
2020N-02V30	D-2
2022NO-04V12	B-5
2022NO-06V12	B-5
2240M-04V30	B-31, J-4
2240N-04V91	B-10, J-3
2340M-04V30	J-4
2340N-04V91	J-3
2370M-06V30	B-34, J-4
2370M-08V30	B-34
2370N-06V91	B-13, J-3
2370N-08V91	B-13
2380M-04V30	B-37, J-4
2380N-04V00	D-10
2380N-04V02	D-10
2380N-04V04	D-10
2380N-04V71	D-10
2380N-04V91	B-16, J-3

<b>Part number</b>	<b>page</b>
2380N-05V71	D-10
2380N-06V10	D-10
2380N-06V91	B-16, J-3
2380N-08V10	D-10
2380N-08V91	B-16, J-3
2380N-20V91	B-16
2390N-06V91	B-19, J-3
2390N-08V12	C-4
2390N-08V13	C-4
2390N-08V16	C-4
2390N-08V91	B-19, J-3
2390N-12V03	C-4
2390N-12V91	B-19, J-3
2390N-16V12	C-4
2390N-16V16	C-4
2390N-16V91	B-19, J-3
2440M-04V30	B-41, J-4
2440M-05V30	B-41
2440M-06V30	B-41, J-4
2440M-08V30	B-41, J-4
2440N-04V37	D-13
2440N-04V91	B-22, J-3
2440N-06V37	D-13
2440N-06V91	B-22, J-3
2440N-08V37	D-13
2440N-08V91	B-22, J-3
2440N-12V37	D-13
2440N-12V91	B-22, J-3
2440N-16V37	D-13
2440N-16V80	E-2
2440N-16V91	B-22, J-3
2440N-24V80	E-2
2440N-32V80	E-2, J-4
2448M-04V30	B-43
2448M-05V30	B-43, J-4
2448M-06V30	B-43, J-4
2448N-04V91	B-26, J-3
2448N-06V91	B-26, J-3
2580N-08V91	J-3
2640M-08V30	J-4
2640N-08V91	B-28, J-3
2640N-12V91	B-28, J-3
2640N-16V80	E-5
2640N-16V91	B-28, J-3
2640N-24V80	E-5, J-4
2640N-32V80	E-5, J-4
6015X-32-24-TC	E-3
6015X-32-32-TC	E-3
10155-4-3C	D-5
10155-4-4C	B-3
10155-6-6C	B-3



<b>Part number</b>	<b>page</b>	<b>Part number</b>	<b>page</b>
10155-8-8C	B-3	C10-116-5202	H-13
10158H-12-12C	B-3	C10-116-6202	H-13
10158H-16-16C	B-3	C10-116-6402	H-13
10655-4-3C	D-5	C10-125-1202	H-13
10655-4-4C	B-3	C10-125-5202	H-14
10655-6-6C	B-3	C10-125-6202	H-14
10655-8-8C	B-3	C19-950-0029	H-15
10658H-12-12C	B-3	C19-950-0062	H-15
10658H-16-16C	B-3	C19-950-0064	H-15
015301	I-4	C19-950-1600	H-15
015306	I-4	C19-950-1601	H-15
015307	I-4	C19-950-1602	H-15
015308	I-4	C19-950-1622	H-15
015309	I-4	C19-950-1623	H-15
015736	I-4	C19-950-1680	H-15
19255-4-3C	D-6	CV5Y-4C-20	G-52
19255-4-4C	D-6	CV5Y-6C-20	G-52
19255-6-6C	D-6	CV5Y-9C-20	G-52
19255-8-8C	D-6	CV6Y-4C-60	G-61
AV5Y-4C-20	G-49	CV6Y-6C-60	G-61
AV5Y-6C-20	G-49	CV6Y-9C-60	G-61
AV5Y-9C-20	G-49	E213JFC4	B-20, C-5
AV5Y-12C-20	G-49	E225JIC3	B-20, C-5
AV5Y-16C-20	G-49	H580N-16	C-2
AV6Y-4C-30	G-54	HAHM4BM4	H-15
AV6Y-4C-60	G-58	HBPHM4-B	G-42
AV6Y-6C-30	G-54	HBPHM6-B	G-42
AV6Y-6C-60	G-58	HBPHM9-B	G-42
AV6Y-9C-30	G-54	HBPLM4-B	G-31
AV6Y-9C-60	G-58	HBPLM6-B	G-31
BSC-1	I-4	HBPLM9-B	G-31
C09-125-1680	H-15	HBPLM12-B	G-31
C10-115-1202	H-10	HBPLM16-B	G-31
C10-115-1222	H-10	HP-3	D-7
C10-115-1401	H-10	HP-3-Gauge	I-3
C10-115-1402	H-10	HP-4	D-7
C10-115-1404	H-10	HP-4-Gauge	I-3
C10-115-1422	H-10	HP006-0-A9	H-3
C10-115-1452	H-10	HP006-0-A12	H-3
C10-115-1454	H-10	HP006-0-HM4	H-3
C10-115-6202	H-11	HP006-0-HM9	H-3
C10-115-6204	H-11	HP006-0-LM6	H-3
C10-115-6401	H-11	HP006-0-NFB	H-3
C10-115-6402	H-11	HP006-0-NFC	H-3
C10-115-6404	H-11	HP006-0-NMB	H-3
C10-115-6452	H-11	HP006-0-NMC	H-3
C10-115-6454	H-11	HP006-0-NMD	H-3
C10-116-1202	H-12	HP006-0-X13	H-3
C10-116-1222	H-12	HP006-1-A9	H-4
C10-116-1402	H-12	HP006-1-A12	H-4
C10-116-1422	H-12	HP006-1-HM4	H-4

**Index**

<b>Part number</b>	<b>page</b>
HP006-1-LM6	H-4
HP006-1-LM9	H-4
HP006-1-NMB	H-4
HP006-1-NMC	H-4
HP006-1-NMD	H-4
HP006-1-X13	H-4
HP006-2-A9	H-5
HP006-2-A12	H-5
HP006-2-HM4	H-5
HP006-2-LM6	H-5
HP006-2-NFB	H-5
HP006-2-NFC	H-5
HP006-2-NMB	H-5
HP006-2-NMC	H-5
HP006-2-NMD	H-5
HP006-2-X13	H-5
HP-6-Gauge	I-3
HP8-3	D-7
HP8-4	D-7
HP8X-6	D-7
HP010-0-A12	H-6
HP010-0-A16	H-6
HP010-0-LM12	H-6
HP010-0-NFD	H-6
HP010-0-NMD	H-6
HP010-0-X23	H-6
HP010-1-A12	H-7
HP010-1-A16	H-7
HP010-1-LM9	H-7
HP010-1-LM12	H-7
HP010-1-NMD	H-7
HP010-1-X23	H-7
HP010-2-A12	H-8
HP010-2-A16	H-8
HP010-2-NFD	H-8
HP010-2-NMD	H-8
HP010-2-X23	H-8
HPX-6	D-7
L5Y-4C	G-29
L5Y-6C	G-29
L5Y-9C	G-29
L5Y-12C	G-29
L5Y-16C	G-29
L6Y-4C	G-40
L6Y-6C	G-40
L6Y-9C	G-40
MCG001SS	I-2
MCG002SS	I-2
MCG003SS	I-2
MCG005SS	I-2
MCGHS10-15	I-2

<b>Part number</b>	<b>page</b>
MCGHS15-20	I-2
MCGHS20-30	I-2
MCGHS30-40	I-2
MCGHS40-50	I-2
MCGHS50-60	I-2
MK022-03-038	I-2
MK022-03-039	I-2
MK022-03-041	I-2
MK022-03-042	I-2
MK022-03-043	I-2
MK022-03-045	I-2
MSG060	I-2
MSG1006	I-2
MSG2006	I-2
MSG2106	I-2
MSG4113	I-2
MSG4120	I-2
MSG4125	I-2
MSG6020	I-2
MTM04T	I-2
SV5Y-4C-20	G-48
SV5Y-6C-20	G-48
SV5Y-9C-20	G-48
SV5Y-12C-20	G-48
SV5Y-16C-20	G-48
SV6Y-4C-30	G-53
SV6Y-4C-60	G-57
SV6Y-6C-30	G-53
SV6Y-6C-60	G-57
SV6Y-9C-30	G-53
SV6Y-9C-60	G-57
T5Y-4C	G-29
T5Y-6C	G-29
T5Y-9C	G-29
T5Y-12C	G-29
T5Y-16C	G-29
T6Y-4C	G-40
T6Y-6C	G-40
T6Y-9C	G-40
TV15Y-4C-20	G-51
TV15Y-6C-20	G-51
TV15Y-9C-20	G-51
TV15Y-12C-20	G-51
TV15Y-16C-20	G-51
TV16Y-4C-30	G-56
TV16Y-4C-60	G-60
TV16Y-6C-30	G-56
TV16Y-6C-60	G-60
TV16Y-9C-30	G-56
TV16Y-9C-60	G-60
TV25Y-4C-20	G-50

Index of part nos

<b>Part number</b>	<b>page</b>	<b>Part number</b>	<b>page</b>
TV25Y-6C-20.....	G-50	Y5Y6-16-9C.....	G-26
TV25Y-9C-20.....	G-50	Y6Y6-4-4C.....	G-36
TV25Y-12C-20.....	G-50	Y6Y6-4-6C.....	G-36
TV25Y-16C-20.....	G-50	Y6Y6-4-9C.....	G-36
TV26Y-4C-30.....	G-55	Y6Y6-6-6C.....	G-36
TV26Y-4C-60.....	G-59	Y6Y6-6-9C.....	G-36
TV26Y-6C-30.....	G-55	Y6Y6-9-9C.....	G-36
TV26Y-6C-60.....	G-59	Y204-0275C.....	G-31
TV26Y-9C-30.....	G-55	Y204-0300C.....	G-31
TV26Y-9C-60.....	G-59	Y204-0400C.....	G-31
X5Y-4C.....	G-30	Y204-0600C.....	G-31
X5Y-6C.....	G-30	Y204-0800C.....	G-31
X5Y-9C.....	G-30	Y204-1000C.....	G-31
X5Y-12C.....	G-30	Y204-1200C.....	G-31
X5Y-16C.....	G-30	Y206-0300C.....	G-31
X6Y-4C.....	G-41	Y206-0400C.....	G-31
X6Y-6C.....	G-41	Y206-0600C.....	G-31
X6Y-9C.....	G-41	Y206-0800C.....	G-31
Y2N-4C.....	G-30	Y206-1000C.....	G-31
Y2N-6C.....	G-30	Y206-1200C.....	G-31
Y2N-9C.....	G-30	Y209-0400C.....	G-31
Y2N-12C.....	G-30	Y209-0600C.....	G-31
Y2N-16C.....	G-30	Y209-0800C.....	G-31
Y4N-4C.....	G-41	Y209-1000C.....	G-31
Y4N-6C.....	G-41	Y209-1200C.....	G-31
Y4N-9C.....	G-41	Y212-0400C.....	G-31
Y5Y5-4-4C.....	G-25	Y212-0600C.....	G-31
Y5Y5-4-6C.....	G-25	Y212-0800C.....	G-31
Y5Y5-4-12C.....	G-25	Y212-1000C.....	G-31
Y5Y5-4-16C.....	G-25	Y212-1200C.....	G-31
Y5Y5-6-6C.....	G-25	Y216-0600C.....	G-31
Y5Y5-6-9C.....	G-25	Y216-0800C.....	G-31
Y5Y5-6-12C.....	G-25	Y216-1000C.....	G-31
Y5Y5-6-16C.....	G-25	Y216-1200C.....	G-31
Y5Y5-9-9C.....	G-25	Y404-0275C.....	G-42
Y5Y5-9-12C.....	G-25	Y404-0300C.....	G-42
Y5Y5-9-16C.....	G-25	Y404-0400C.....	G-42
Y5Y5-12-12C.....	G-25	Y404-0600C.....	G-42
Y5Y5-12-16C.....	G-25	Y404-0800C.....	G-42
Y5Y6-4-4C.....	G-26	Y404-1000C.....	G-42
Y5Y6-4-6C.....	G-26	Y404-1200C.....	G-42
Y5Y6-4-9C.....	G-26	Y406-0300C.....	G-42
Y5Y6-6-4C.....	G-26	Y406-0600C.....	G-42
Y5Y6-6-9C.....	G-26	Y406-0800C.....	G-42
Y5Y6-9-4C.....	G-26	Y406-1000C.....	G-42
Y5Y6-9-9C.....	G-26	Y406-1200C.....	G-42
Y5Y6-12-4C.....	G-26	Y409-0275C.....	G-42
Y5Y6-12-6C.....	G-26	Y409-0400C.....	G-42
Y5Y6-12-9C.....	G-26	Y409-0600C.....	G-42
Y5Y6-16-4C.....	G-26	Y409-0800C.....	G-42
Y5Y6-16-6C.....	G-26	Y409-1000C.....	G-42

**Index**

<b>Part number</b>	<b>page</b>	<b>Part number</b>	<b>page</b>
Y409-1200C .....	G-42	YA01-16-16C .....	G-11
Y501-4-4C .....	G-27	YA01-16-20C .....	G-11
Y501-4-8C .....	G-27	YA01-16-24C .....	G-11
Y501-6-4C .....	G-27	YA01-16-32C .....	G-11
Y501-6-6C .....	G-27	YA02-6-4C .....	G-10
Y501-6-8C .....	G-27	YA02-6-8C .....	G-10
Y501-9-2C .....	G-27	YA02-8-8C .....	G-10
Y501-9-4C .....	G-27	YA02-11-8C .....	G-10
Y501-9-6C .....	G-27	YA6C-CAP .....	G-7
Y501-9-8C .....	G-27	YA6C-PLUG .....	G-7
Y501-9-12C .....	G-27	YA8C-CAP .....	G-7
Y501-9-16C .....	G-27	YA8C-PLUG .....	G-7
Y501-12-2C .....	G-27	YA11C-CAP .....	G-7
Y501-12-4C .....	G-27	YA11C-PLUG .....	G-7
Y501-12-6C .....	G-27	YA16C-CAP .....	G-7
Y501-12-8C .....	G-27	YA16C-PLUG .....	G-7
Y501-12-12C .....	G-27	YAY1-8-16C .....	G-8
Y501-12-16C .....	G-27	YAY1-11-16C .....	G-8
Y501-16-2C .....	G-28	YAY1-16-16C .....	G-8
Y501-16-4C .....	G-28	YAY2-8-16C .....	G-8
Y501-16-6C .....	G-28	YAY2-11-16C .....	G-8
Y501-16-8C .....	G-28	YAY2-16-16C .....	G-8
Y501-16-12C .....	G-28	YAY5-6-4C .....	G-9
Y501-16-16C .....	G-28	YAY5-6-6C .....	G-9
Y601-4-2C .....	G-37	YAY5-6-9C .....	G-9
Y601-4-4C .....	G-37	YAY5-6-12C .....	G-9
Y601-4-6C .....	G-37	YAY5-8-6C .....	G-9
Y601-4-8C .....	G-37	YAY5-8-9C .....	G-9
Y601-4-12C .....	G-37	YAY5-8-12C .....	G-9
Y601-6-4C .....	G-37	YAY5-11-6C .....	G-9
Y601-6-6C .....	G-37	YAY5-11-9C .....	G-9
Y601-9-4C .....	G-37	YAY5-11-12C .....	G-9
Y601-9-6C .....	G-37	YAY5-16-9C .....	G-9
Y601-9-8C .....	G-37	YAY5-16-12C .....	G-9
Y601-9-12C .....	G-37	YAY6-6-4C .....	G-6
Y601-9-16C .....	G-37	YAY6-6-6C .....	G-6
YA01-6-2C .....	G-11	YAY6-6-9C .....	G-6
YA01-6-4C .....	G-11	YAY6-8-6C .....	G-6
YA01-6-6C .....	G-11	YAY6-8-9C .....	G-6
YA01-6-8C .....	G-11	YAY6-10-6C .....	G-6
YA01-8-4C .....	G-11	YAY6-10-9C .....	G-6
YA01-8-6C .....	G-11	YAY6-11-9C .....	G-6
YA01-8-8C .....	G-11	YAYA-6-6C .....	G-5
YA01-8-12C .....	G-11	YAYA-8-6C .....	G-5
YA01-8-16C .....	G-11	YAYA-8-8C .....	G-5
YA01-11-6C .....	G-11	YAYA-10-6C .....	G-5
YA01-11-8C .....	G-11	YAYA-10-10C .....	G-5
YA01-11-12C .....	G-11	YAYA-11-8C .....	G-5
YA01-11-16C .....	G-11	YAYA-11-11C .....	G-5
YA01-16-8C .....	G-11	YAYA-16-11C .....	G-5
YA01-16-12C .....	G-11	YAYA-16-16C .....	G-5

Index of part nos





## Parker Hannifin Corporation

### About Parker Hannifin Corporation

Parker Hannifin is a leading global motion-control company dedicated to delivering premier customer service.

A Fortune 500 corporation listed on the New York Stock Exchange (PH), our components and systems comprise over 1,400 product lines that control motion in some 1,000 industrial and aerospace markets. Parker is the only manufacturer to offer its customers a choice of hydraulic, pneumatic, and electromechanical motion-control solutions. Our Company has the largest distribution network in its field, with over 7,500 distributors serving nearly 400,000 customers worldwide.

### Parker's Charter

To be a leading worldwide manufacturer of components and systems for the builders and users of durable goods. More specifically, we will design, market and manufacture products controlling motion, flow and pressure. We will achieve profitable growth through premier customer service.

### Product Information

Customers seeking product information, the location of a nearby distributor, or repair services will receive prompt attention by calling the Parker Product Information Centre.

The Centre can be called toll free from France, Germany, Austria, Switzerland or the United Kingdom. You will be answered by a Parker employee in your own language. Call Freephone: 00800-2727-5374 (00800 C PARKER H)

#### The Aerospace Group

is a leader in the development, design, manufacture and servicing of control systems and components for aerospace and related high-technology markets, while achieving growth through premier customer service.



#### The Climate & Industrial Controls Group

designs, manufactures and markets system-control and fluid-handling components and systems to refrigeration, air-conditioning and industrial customers worldwide.



#### The FluidConnectors Group

designs, manufactures and markets rigid and flexible connectors, and associated products used in pneumatic and fluid systems.



#### The Seal Group

designs, manufactures and distributes industrial and commercial sealing devices and related products by providing superior quality and total customer satisfaction.



#### The Hydraulics Group

designs, produces and markets a full spectrum of hydraulic components and systems to builders and users of industrial and mobile machinery and equipment.



#### The Filtration Group

designs, manufactures and markets quality filtration and clarification products, providing customers with the best value, quality, technical support, and global availability.



#### The Automation Group

is a leading supplier of pneumatic and electromechanical components and systems to automation customers worldwide.



#### The Instrumentation Group

is a global leader in the design, manufacture and distribution of high-quality critical flow components for worldwide process instrumentation, ultra-high-purity, medical and analytical applications.



# Sales Offices Worldwide

## **AE - United Arab Emirates**

Abu Dhabi  
Tel.: +971 2 678 8587

## **AT - Austria**

Wiener Neustadt  
Tel.: +43 (0)2622 23501

## **AU - Australia**

Castle Hill  
Tel.: +61 (0)2-9634 7777

## **AZ - Azerbaijan**

Baku  
Tel/Fax: +99 412 598 3966

## **BE - Belgium**

Nivelles  
Tel.: +32 (0)67 280 900

## **BR - Brazil**

Jacarei, SP  
Tel.: +55 12 3954 5100

## **BY - Belarus**

Minsk  
Tel.: +375 17 209 9399

## **CA - Canada**

Grimsby, ON  
Tel.: +1 905-945-2274

## **CZ - Czech Republic**

Klečany  
Tel.: +420 284 083 111

## **DE - Germany**

Kaarst  
Tel.: +49 (0)2131 4016 0

## **DK - Denmark**

Ballerup  
Tel.: +45 4356 0400

## **EG - Egypt**

Cairo  
Tel.: +20 2 519 4018

## **ES - Spain**

Madrid  
Tel.: +34 91 675 73 00

## **FI - Finland**

Vantaa  
Tel.: +358 (0) 20 753 2500

## **FR - France**

Contamine-sur-Arve  
Tel.: +33 (0)4 50 25 80 25

## **GR - Greece**

Athens  
Tel.: +30 210 933 6450

## **HK - Hong Kong**

Kowloon  
Tel.: +852 2428 8008

## **HU - Hungary**

Budapest  
Tel.: +36 (1) 220 4155

## **IE - Ireland**

Dublin  
Tel.: +353 (0)1 466 6370

## **IN - India**

Mumbai  
Tel.: +91 22 7907081

## **IT - Italy**

Corsico (MI)  
Tel.: +39 02 451 921

## **KZ - Kazakhstan**

Almaty  
Tel.: +7 3272 505 800

## **NL - Netherlands**

Oldenzaal  
Tel.: +31 (0)541 585000

## **NO - Norway**

Ski  
Tel.: +47 64 91 10 00

## **PL - Poland**

Warszawa  
Tel.: +48 (0) 22 573 24 00

## **PT - Portugal**

Leça da Palmeira  
Tel.: +351 22 999 7360

## **RO - Romania**

Bucharest  
Tel.: +40 21 252 1382

## **RU - Russia**

Moscow  
Tel.: +7 495 645-2156

## **RU - Russia**

Yuzhno-Sakhalinsk  
Tel/Fax: +7 4242 752 742

## **SE - Sweden**

Spånga  
Tel.: +46 (0) 8 59 79 5000

## **SG - Singapore**

Singapore  
Tel.: +65 6887 6300

## **SL - Slovenia**

Novo Mesto  
Tel.: +386 (7) 337 6650

## **TR - Turkey**

Merter/Istanbul  
Tel.: +90 212 482 91 06/07

## **UA - Ukraine**

Kyiv  
Tel.: +380 (0) 44 494 2731

## **UK - United Kingdom**

Derby  
Tel.: +44 (0) 1332 36 56 31

## **US - USA**

Stafford, TX  
Tel.: +1 281 925 4500

## **ZA - South Africa**

Kempton Park  
Tel.: +27 11 961 0700

Edition August 2007 / Catalogue 4465  
hsh / PlantijnCasparie

Parker Hannifin Corporation  
**polyflex** Division  
An der Tuchbleiche 4  
68623 Lampertheim (Hüttenfeld)  
Tel.: +49 (0)6256 81-0  
Fax: +49 (0)6256 81-100



Internet: <http://www.parker.com>